

Single Ply Membrane Details
Mechanically Fixed System
Upstand detail

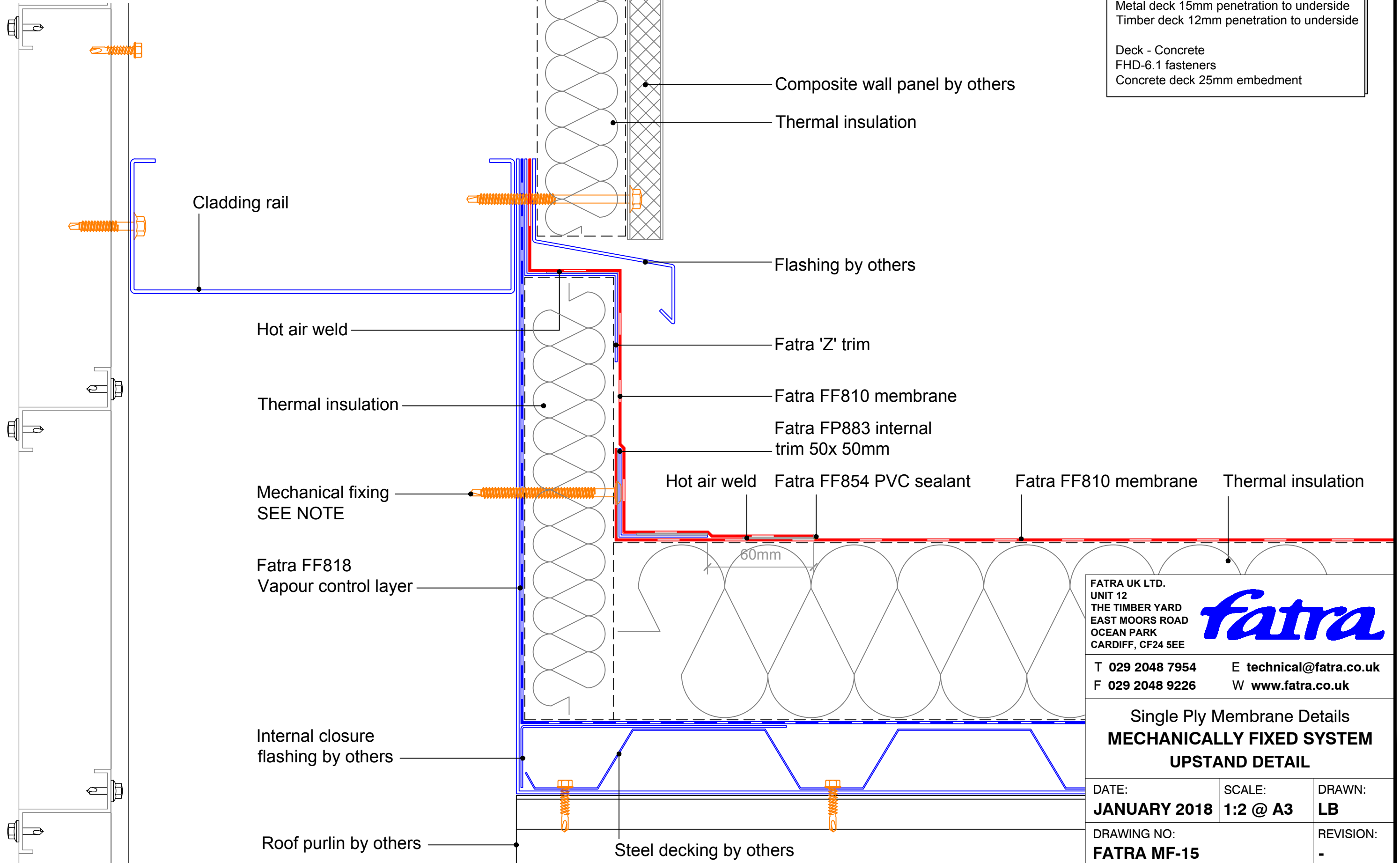

MECHANICAL FIXINGS:-

Selection of fixings:-
 Deck - Metal/Timber/plywood
 FBS-5.8 fasteners
 Metal deck 15mm penetration to underside
 Timber deck 12mm penetration to underside

Deck - Concrete
 FHD-6.1 fasteners
 Concrete deck 25mm embedment

FATRA UK LTD.
 UNIT 12
 THE TIMBER YARD
 EAST MOORS ROAD
 OCEAN PARK
 CARDIFF, CF24 5EE

fatra

T 029 2048 7954 E technical@fatra.co.uk
 F 029 2048 9226 W www.fatra.co.uk

Single Ply Membrane Details
MECHANICALLY FIXED SYSTEM
UPSTAND DETAIL

DATE: JANUARY 2018	SCALE: 1:2 @ A3	DRAWN: LB
DRAWING NO: FATRA MF-15		REVISION: -

Single Ply Membrane Details
Mechanically Fixed System
Rendered upstand detail

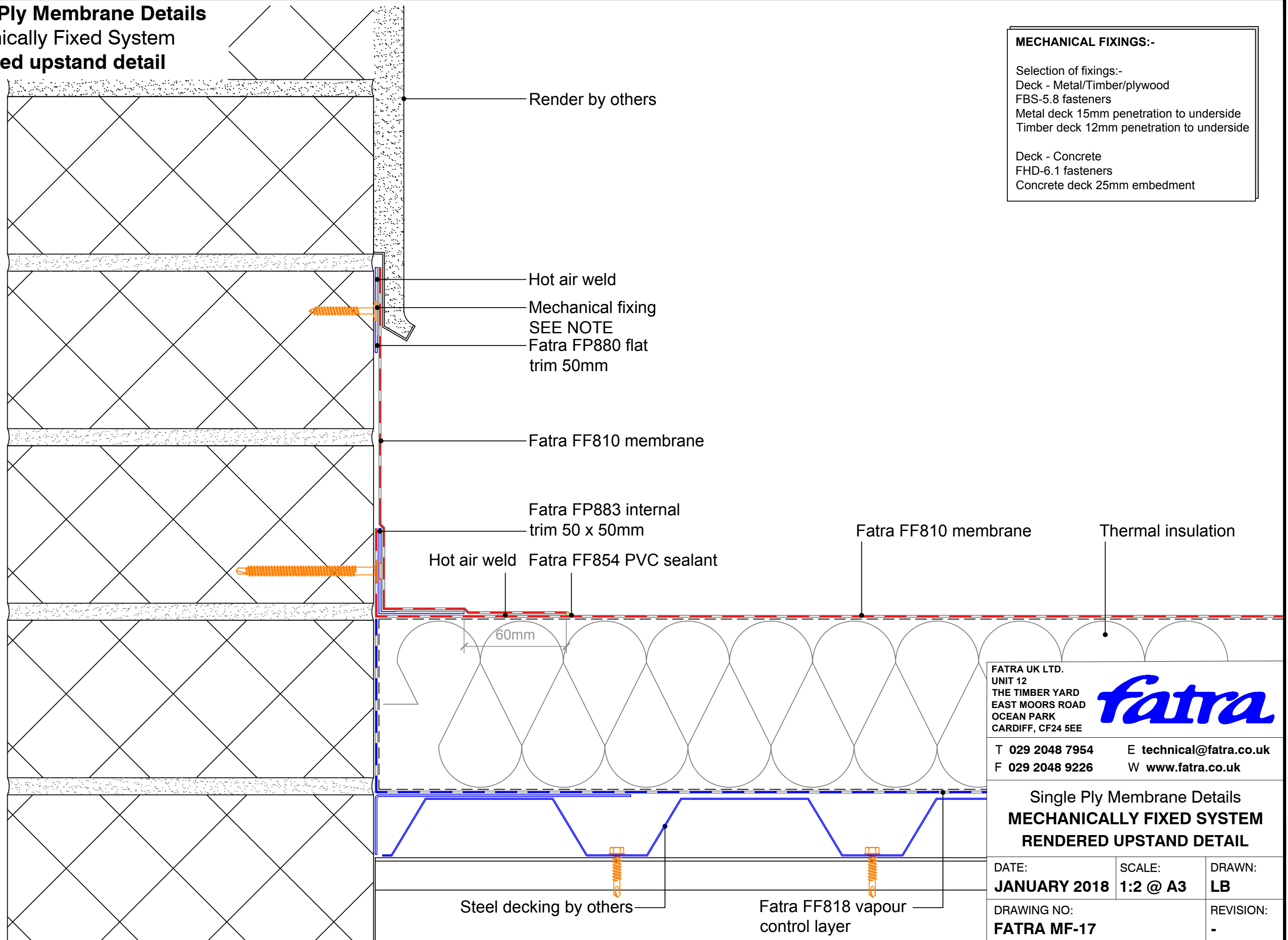

MECHANICAL FIXINGS:-

Selection of fixings:-
 Deck - Metal/Timber/plywood
 FBS-5.8 fasteners
 Metal deck 15mm penetration to underside
 Timber deck 12mm penetration to underside

Deck - Concrete
 FHD-6.1 fasteners
 Concrete deck 25mm embedment

FATRA UK LTD.
 UNIT 12
 THE TIMBER YARD
 EAST MOORS ROAD
 OCEAN PARK
 CARDIFF, CF24 5EE

fatra

T 029 2048 7954 E technical@fatra.co.uk
 F 029 2048 9226 W www.fatra.co.uk

Single Ply Membrane Details
MECHANICALLY FIXED SYSTEM
RENDERED UPSTAND DETAIL

DATE: JANUARY 2018	SCALE: 1:2 @ A3	DRAWN: LB
DRAWING NO: FATRA MF-17		REVISION: -

Single Ply Membrane Details
Mechanically Fixed System
Chase trim detail

MECHANICAL FIXINGS:-

Selection of fixings:-
 Deck - Metal/Timber/plywood
 FBS-5.8 fasteners
 Metal deck 15mm penetration to underside
 Timber deck 12mm penetration to underside

Deck - Concrete
 FHD-6.1 fasteners
 Concrete deck 25mm embedment

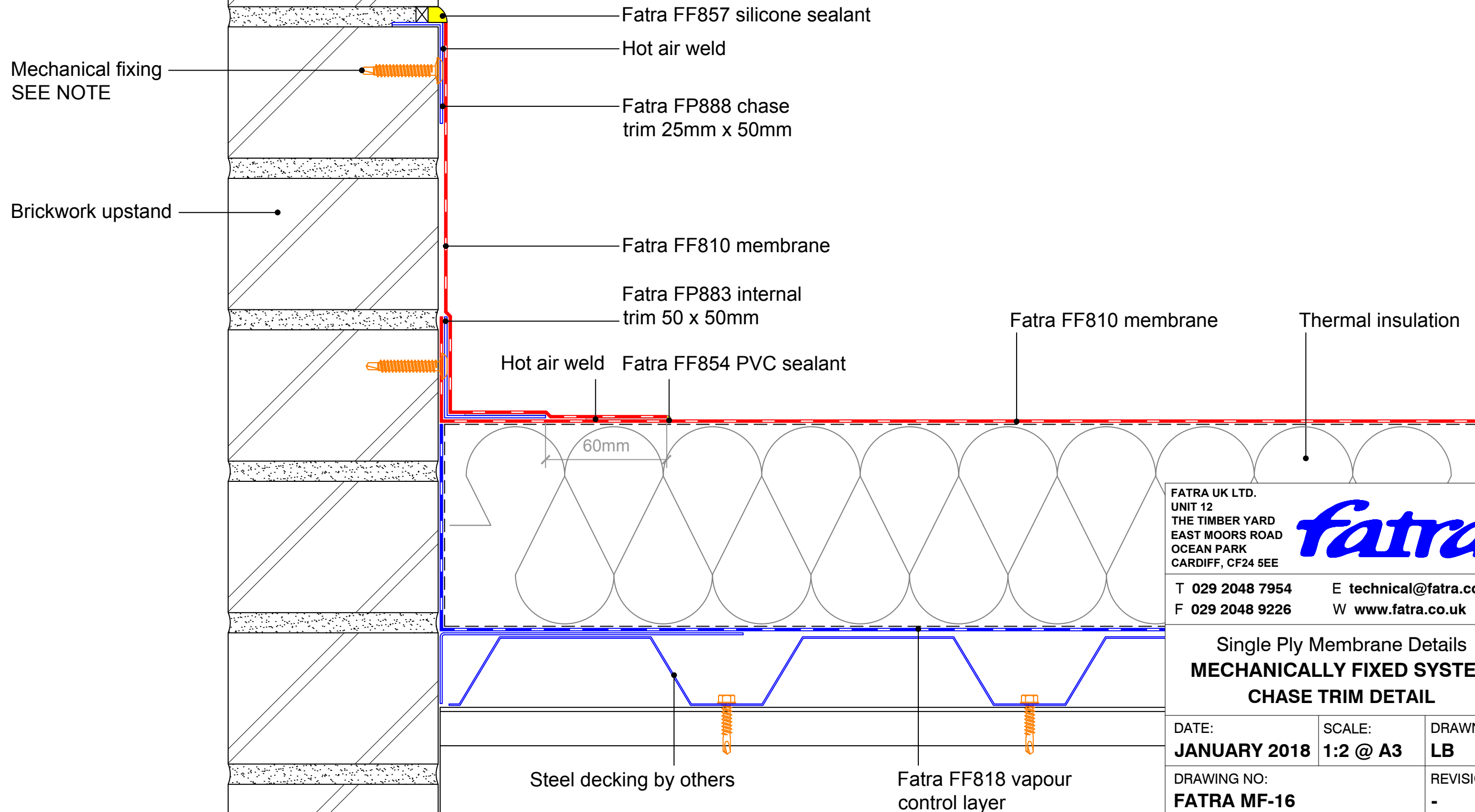

FATRA UK LTD.
 UNIT 12
 THE TIMBER YARD
 EAST MOORS ROAD
 OCEAN PARK
 CARDIFF, CF24 5EE



T 029 2048 7954 E technical@fatra.co.uk
 F 029 2048 9226 W www.fatra.co.uk

Single Ply Membrane Details
MECHANICALLY FIXED SYSTEM
CHASE TRIM DETAIL

DATE: JANUARY 2018	SCALE: 1:2 @ A3	DRAWN: LB
DRAWING NO: FATRA MF-16		REVISION: -

Single Ply Membrane Details
Mechanically Fixed System
Cable penetration detail

MECHANICAL FIXINGS:-

Selection of fixings:-
 Deck - Metal/Timber/plywood
 FBS-5.8 fasteners
 Metal deck 15mm penetration to underside
 Timber deck 12mm penetration to underside

Deck - Concrete
 FHD-6.1 fasteners
 Concrete deck 25mm embedment

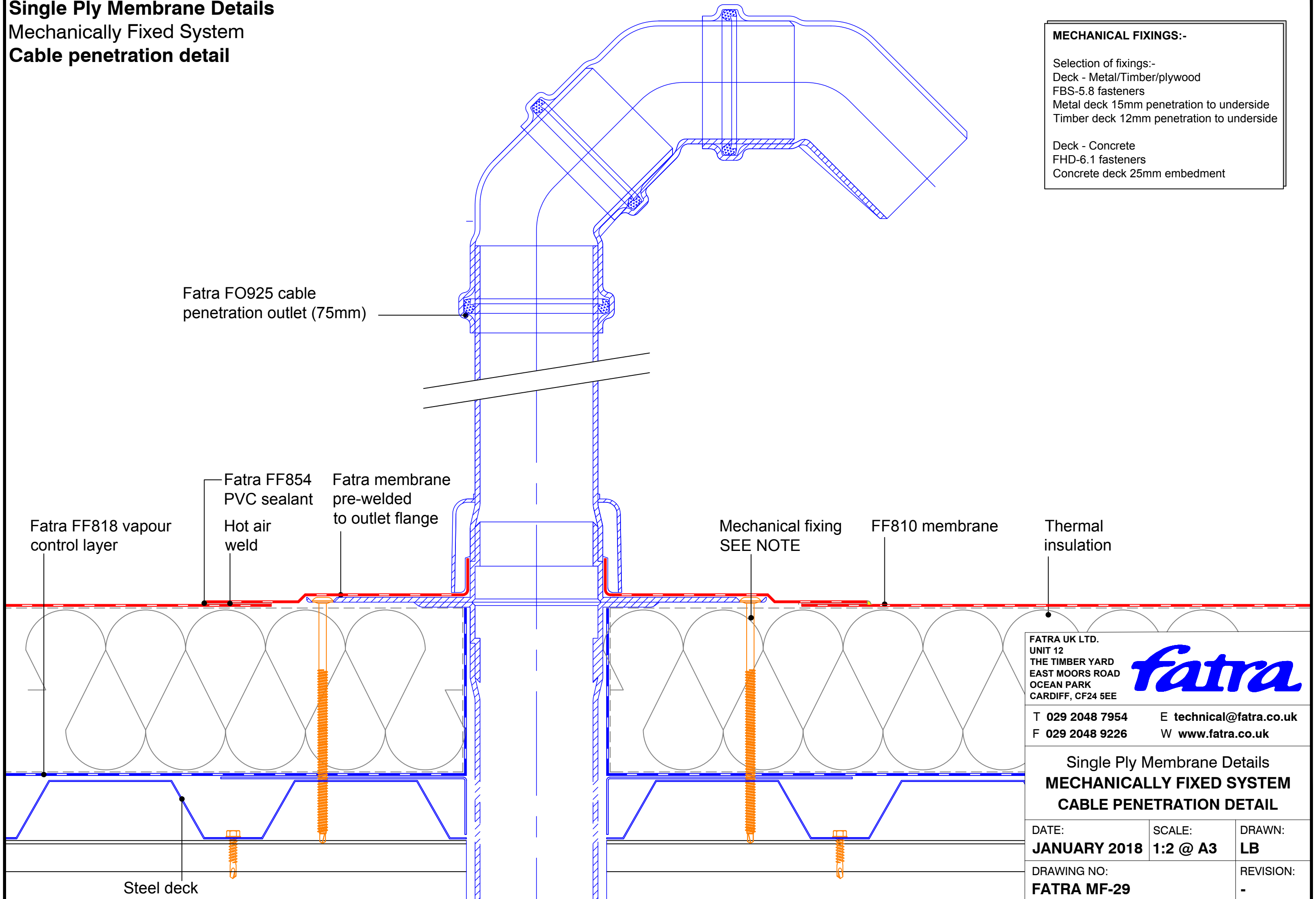

FATRA UK LTD.
 UNIT 12
 THE TIMBER YARD
 EAST MOORS ROAD
 OCEAN PARK
 CARDIFF, CF24 5EE



T 029 2048 7954 E technical@fatra.co.uk
 F 029 2048 9226 W www.fatra.co.uk

Single Ply Membrane Details
MECHANICALLY FIXED SYSTEM
CABLE PENETRATION DETAIL

DATE: JANUARY 2018	SCALE: 1:2 @ A3	DRAWN: LB
DRAWING NO: FATRA MF-29		REVISION: -

Single Ply Membrane Details
Mechanically Fixed System
Cold pipe penetration detail

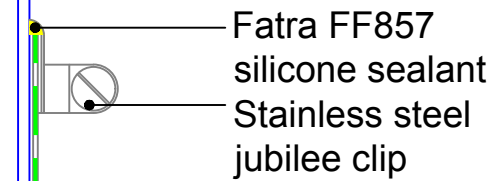
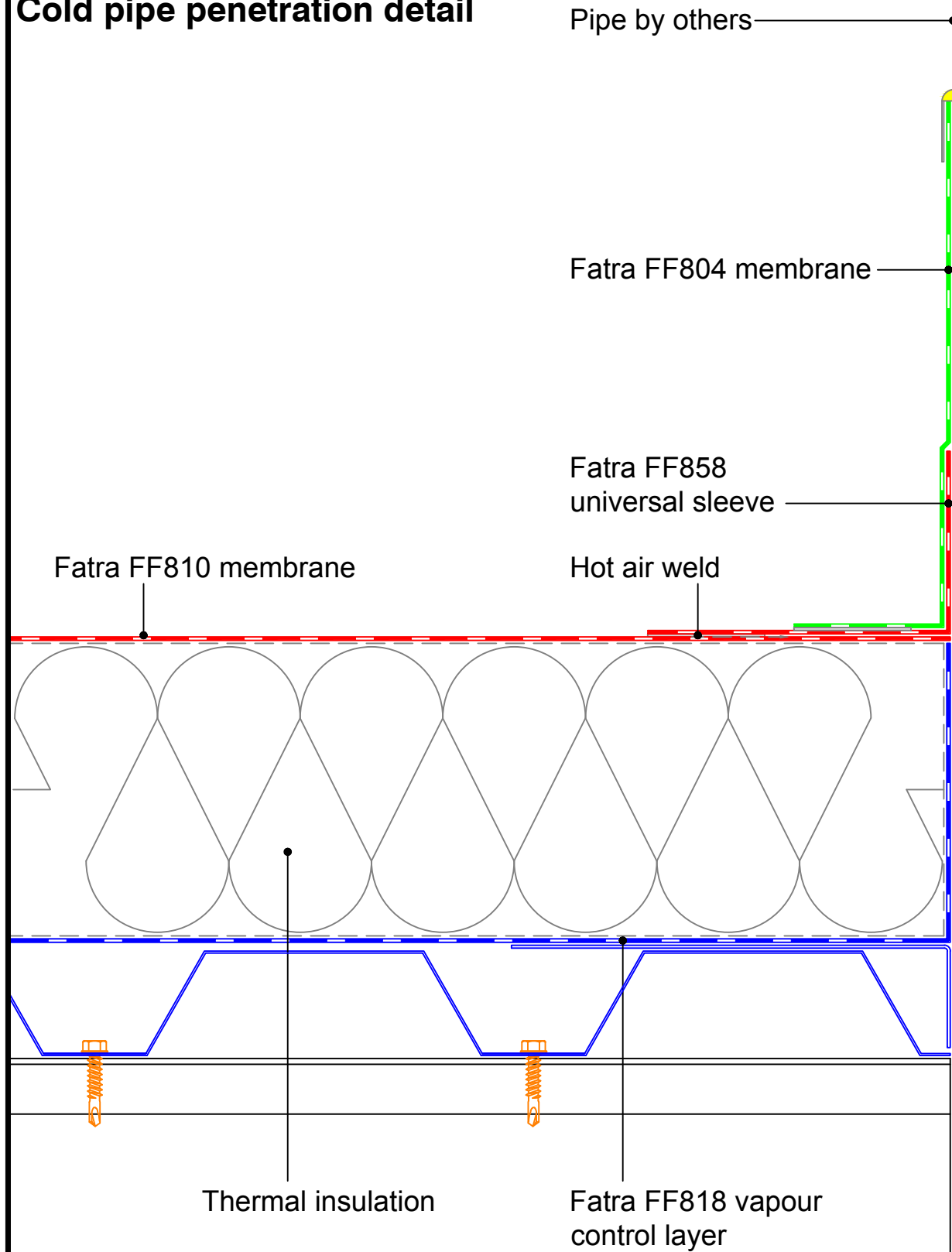

MECHANICAL FIXINGS:-

Selection of fixings:-
 Deck - Metal/Timber/plywood
 FBS-5.8 fasteners
 Metal deck 15mm penetration to underside
 Timber deck 12mm penetration to underside

Deck - Concrete
 FHD-6.1 fasteners
 Concrete deck 25mm embedment

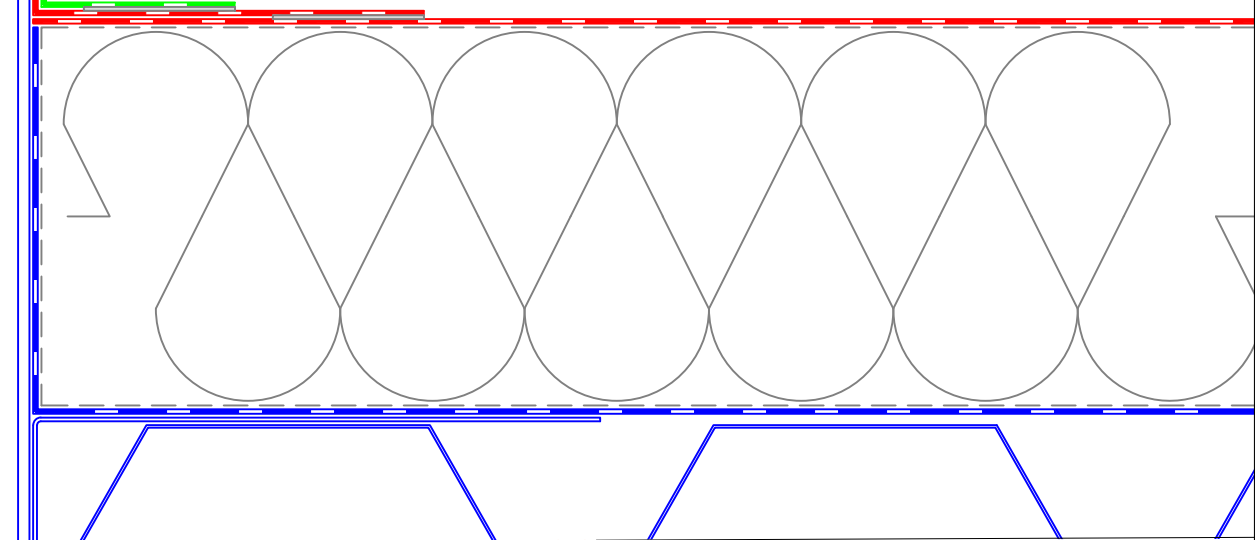

FATRA UK LTD.
 UNIT 12
 THE TIMBER YARD
 EAST MOORS ROAD
 OCEAN PARK
 CARDIFF, CF24 5EE

fatra

T 029 2048 7954 E technical@fatra.co.uk
 F 029 2048 9226 W www.fatra.co.uk

Single Ply Membrane Details
MECHANICALLY FIXED SYSTEM
COLD PIPE PENETRATION DETAIL

DATE: JANUARY 2018	SCALE: 1:2 @ A3	DRAWN: LB
DRAWING NO: FATRA MF-30		REVISION: -

Single Ply Membrane Details
Mechanically Fixed System
Door threshold detail

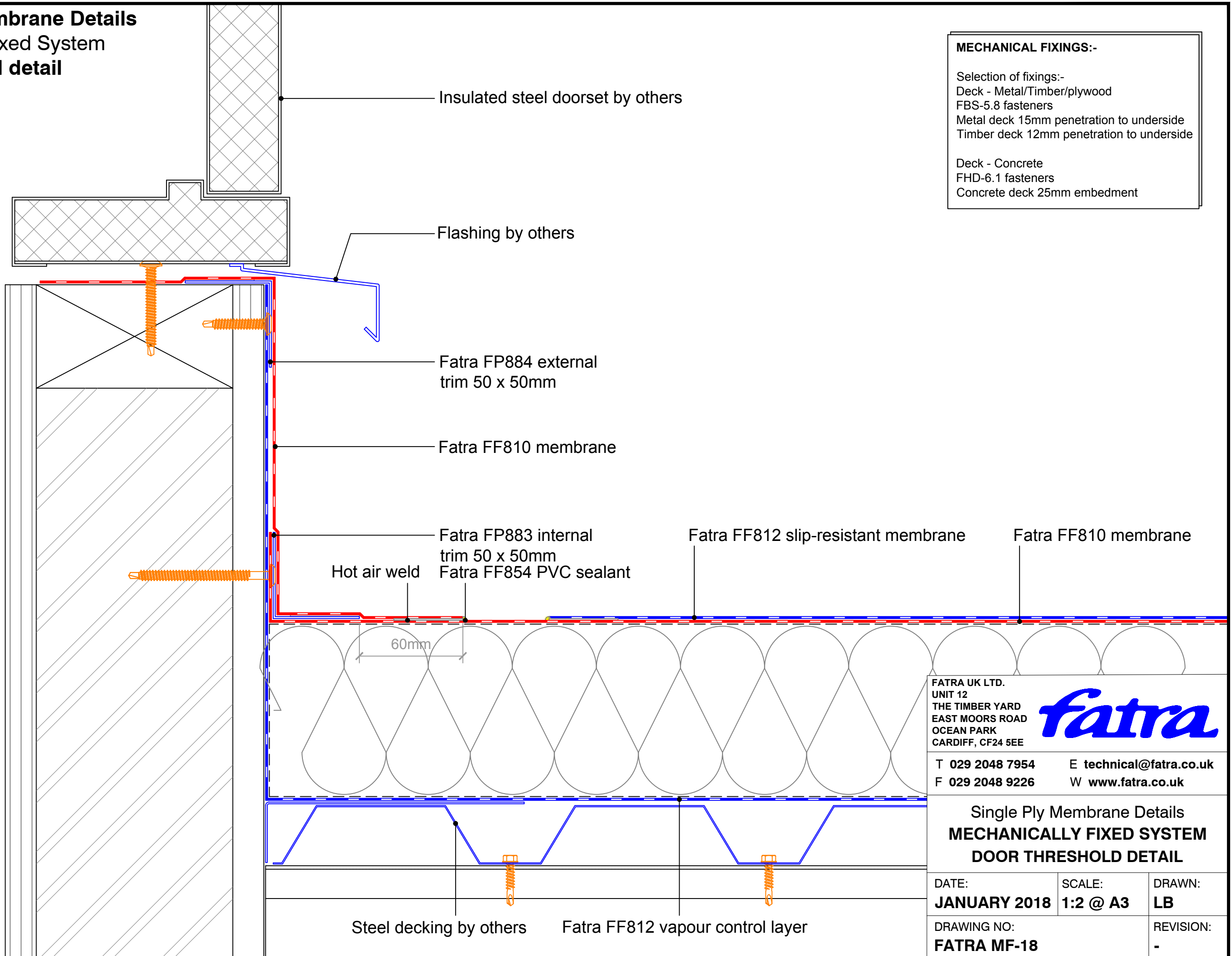

MECHANICAL FIXINGS:-

Selection of fixings:-
 Deck - Metal/Timber/plywood
 FBS-5.8 fasteners
 Metal deck 15mm penetration to underside
 Timber deck 12mm penetration to underside

Deck - Concrete
 FHD-6.1 fasteners
 Concrete deck 25mm embedment

FATRA UK LTD.
 UNIT 12
 THE TIMBER YARD
 EAST MOORS ROAD
 OCEAN PARK
 CARDIFF, CF24 5EE

fatra

T 029 2048 7954 E technical@fatra.co.uk
 F 029 2048 9226 W www.fatra.co.uk

Single Ply Membrane Details
MECHANICALLY FIXED SYSTEM
DOOR THRESHOLD DETAIL

DATE: JANUARY 2018	SCALE: 1:2 @ A3	DRAWN: LB
DRAWING NO: FATRA MF-18		REVISION: -

Single Ply Membrane Details
Mechanically Fixed System
Duct penetration detail

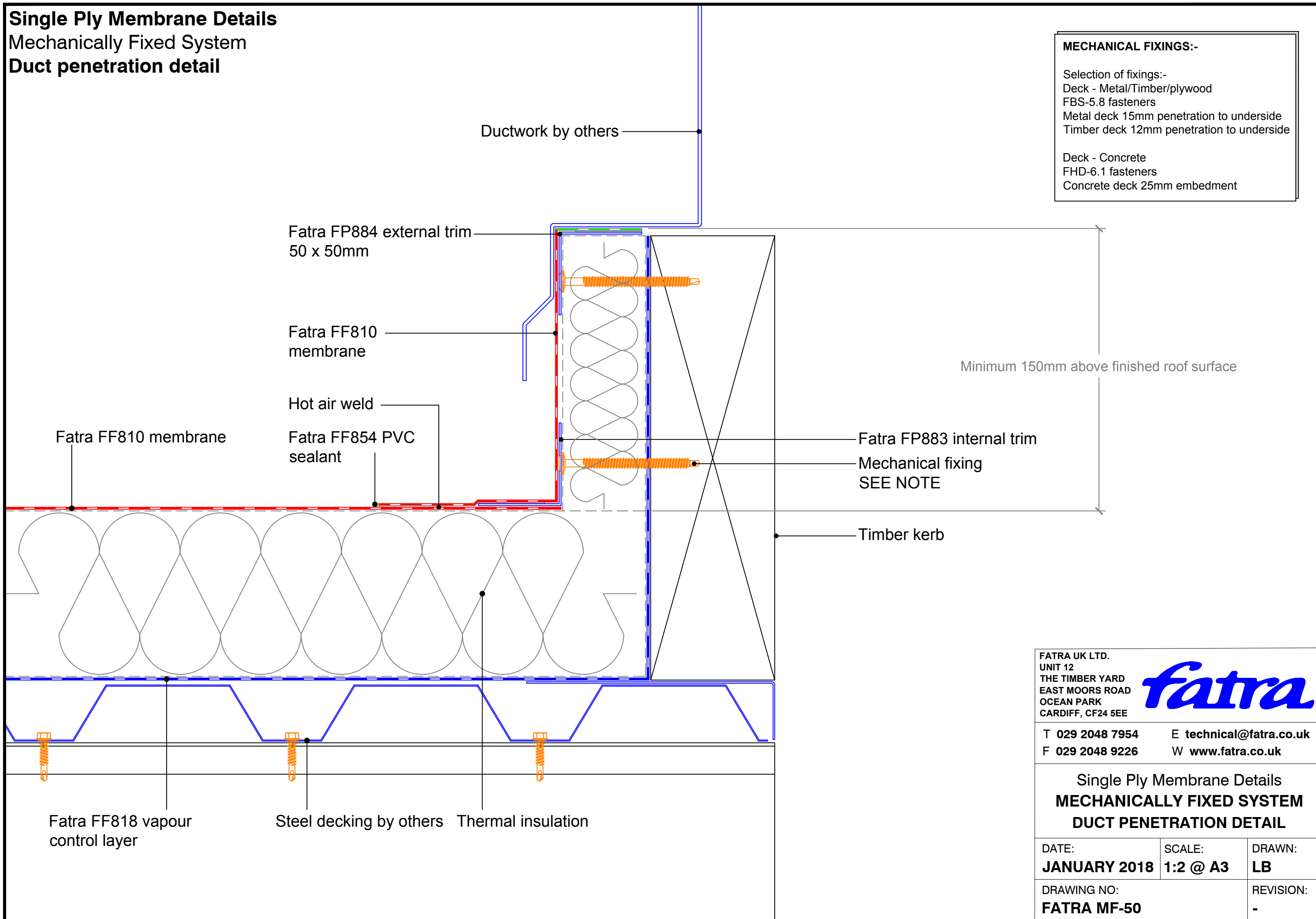

MECHANICAL FIXINGS:-

Selection of fixings:-
 Deck - Metal/Timber/plywood
 FBS-5.8 fasteners
 Metal deck 15mm penetration to underside
 Timber deck 12mm penetration to underside

Deck - Concrete
 FHD-6.1 fasteners
 Concrete deck 25mm embedment

FATRA UK LTD.
 UNIT 12
 THE TIMBER YARD
 EAST MOORS ROAD
 OCEAN PARK
 CARDIFF, CF24 5EE



T 029 2048 7954 E technical@fatra.co.uk
 F 029 2048 9226 W www.fatra.co.uk

Single Ply Membrane Details
MECHANICALLY FIXED SYSTEM
DUCT PENETRATION DETAIL

DATE: JANUARY 2018	SCALE: 1:2 @ A3	DRAWN: LB
------------------------------	---------------------------	---------------------

DRAWING NO: FATRA MF-50	REVISION: -
-----------------------------------	-----------------------

Single Ply Membrane Details
Mechanically Fixed System
Eaves gutter detail

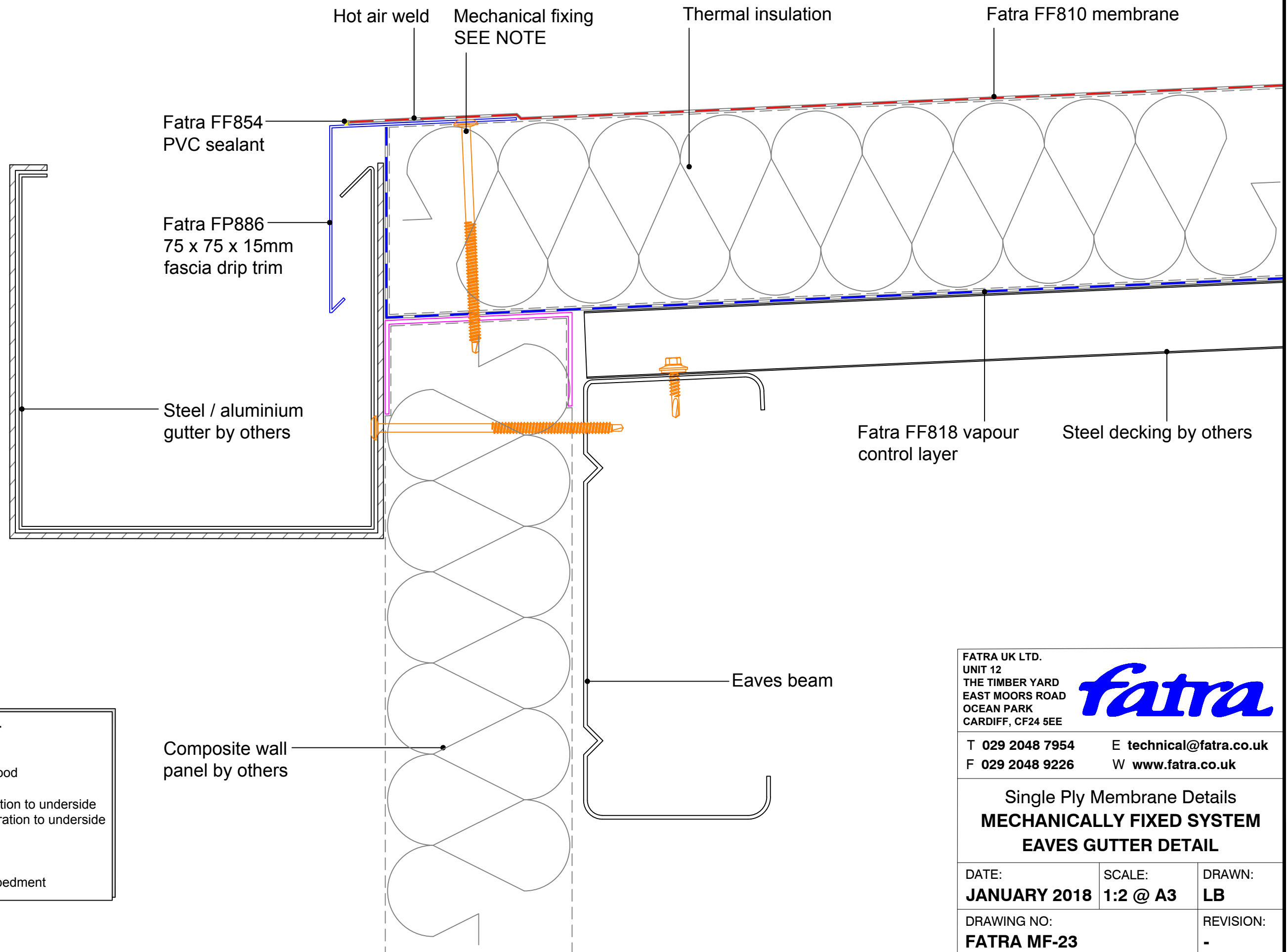

MECHANICAL FIXINGS:-

Selection of fixings:-
 Deck - Metal/Timber/plywood
 FBS-5.8 fasteners
 Metal deck 15mm penetration to underside
 Timber deck 12mm penetration to underside

Deck - Concrete
 FHD-6.1 fasteners
 Concrete deck 25mm embedment

FATRA UK LTD. UNIT 12 THE TIMBER YARD EAST MOORS ROAD OCEAN PARK CARDIFF, CF24 5EE		
T 029 2048 7954 F 029 2048 9226	E technical@fatra.co.uk W www.fatra.co.uk	
Single Ply Membrane Details MECHANICALLY FIXED SYSTEM EAVES GUTTER DETAIL		
DATE: JANUARY 2018	SCALE: 1:2 @ A3	DRAWN: LB
DRAWING NO: FATRA MF-23		REVISION: -

Single Ply Membrane Details
Mechanically Fixed System
Movement joint detail

MECHANICAL FIXINGS:-

Selection of fixings:-
 Deck - Metal/Timber/plywood
 FBS-5.8 fasteners
 Metal deck 15mm penetration to underside
 Timber deck 12mm penetration to underside

Deck - Concrete
 FHD-6.1 fasteners
 Concrete deck 25mm embedment

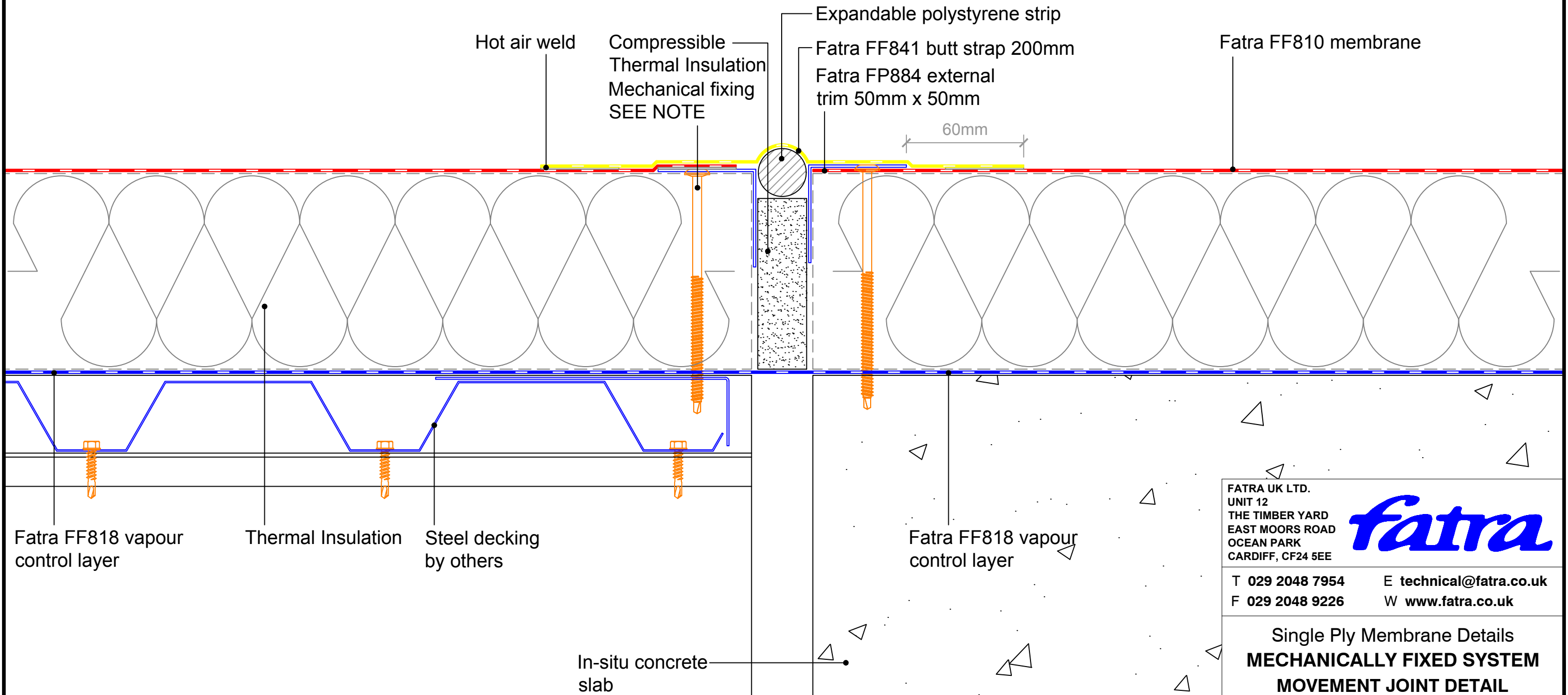

FATRA UK LTD.
 UNIT 12
 THE TIMBER YARD
 EAST MOORS ROAD
 OCEAN PARK
 CARDIFF, CF24 5EE



T 029 2048 7954 E technical@fatra.co.uk
 F 029 2048 9226 W www.fatra.co.uk

Single Ply Membrane Details
MECHANICALLY FIXED SYSTEM
MOVEMENT JOINT DETAIL

DATE: JANUARY 2018	SCALE: 1:2 @ A3	DRAWN: LB
DRAWING NO: FATRA MF-06		REVISION: -

Single Ply Membrane Details
Mechanically Fixed System
Fall arrest post detail 2

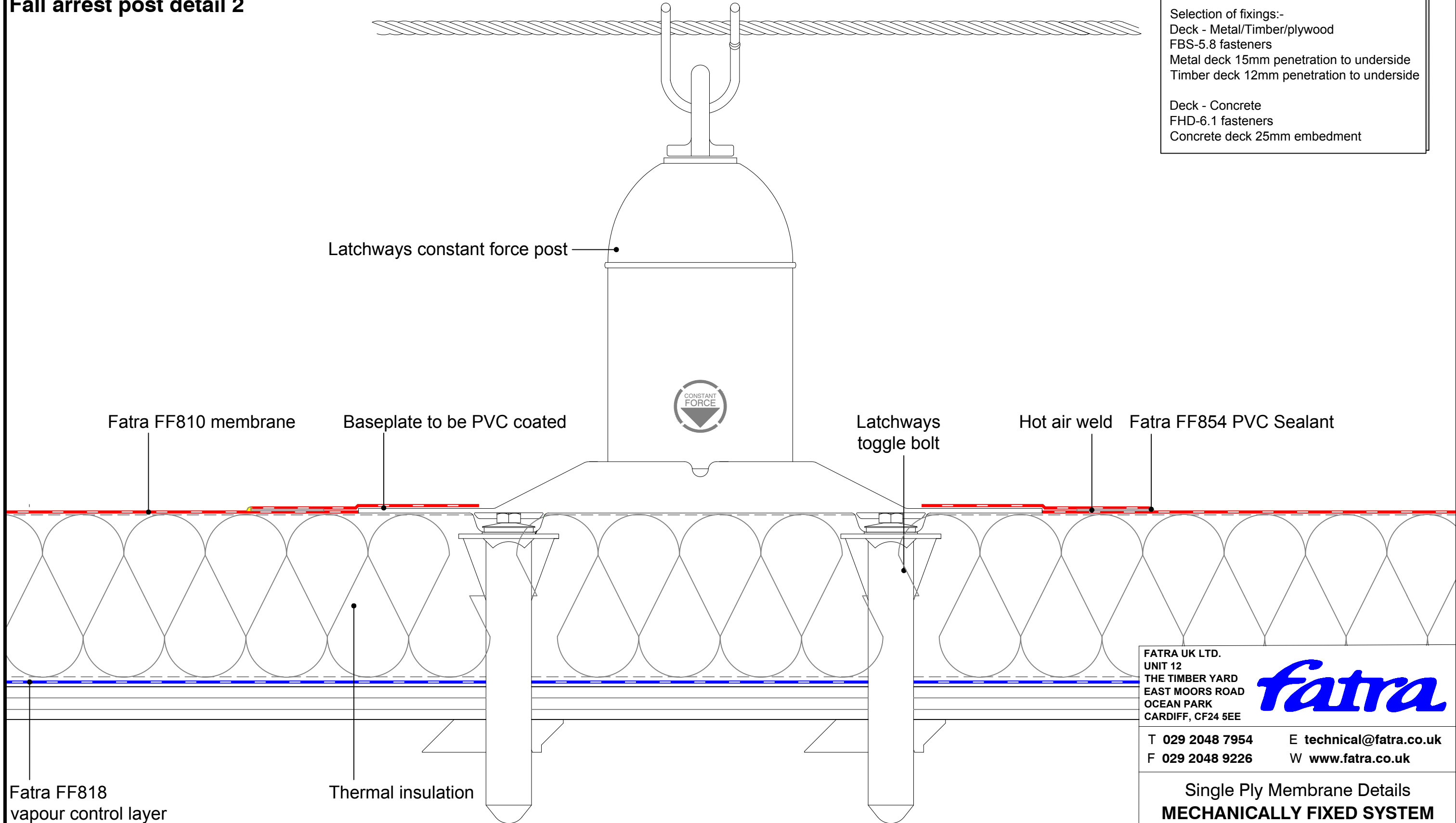

MECHANICAL FIXINGS:-

Selection of fixings:-
 Deck - Metal/Timber/plywood
 FBS-5.8 fasteners
 Metal deck 15mm penetration to underside
 Timber deck 12mm penetration to underside

Deck - Concrete
 FHD-6.1 fasteners
 Concrete deck 25mm embedment

FATRA UK LTD.
 UNIT 12
 THE TIMBER YARD
 EAST MOORS ROAD
 OCEAN PARK
 CARDIFF, CF24 5EE

fatra

T 029 2048 7954 E technical@fatra.co.uk
 F 029 2048 9226 W www.fatra.co.uk

Single Ply Membrane Details
MECHANICALLY FIXED SYSTEM
FALL ARREST POST DETAIL 2

DATE: JANUARY 2018	SCALE: 1:2 @ A3	DRAWN: LB
DRAWING NO: FATRA MF-35		REVISION: -

Single Ply Membrane Details
Mechanically Fixed System
Fall arrest post detail 1

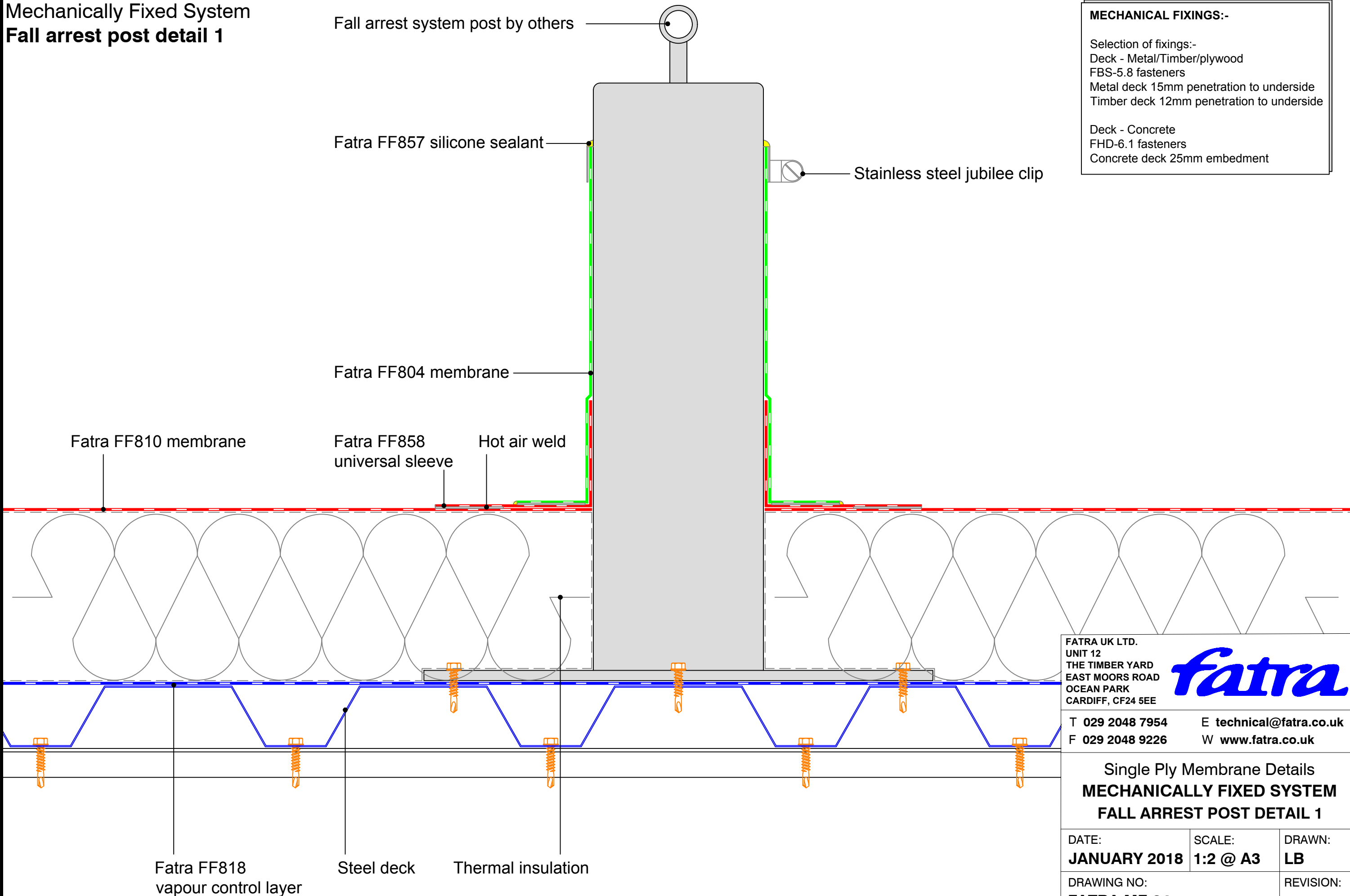

MECHANICAL FIXINGS:-

Selection of fixings:-
 Deck - Metal/Timber/plywood
 FBS-5.8 fasteners
 Metal deck 15mm penetration to underside
 Timber deck 12mm penetration to underside

Deck - Concrete
 FHD-6.1 fasteners
 Concrete deck 25mm embedment

FATRA UK LTD.
 UNIT 12
 THE TIMBER YARD
 EAST MOORS ROAD
 OCEAN PARK
 CARDIFF, CF24 5EE

fatra

T 029 2048 7954 E technical@fatra.co.uk
 F 029 2048 9226 W www.fatra.co.uk

Single Ply Membrane Details
MECHANICALLY FIXED SYSTEM
FALL ARREST POST DETAIL 1

DATE: JANUARY 2018	SCALE: 1:2 @ A3	DRAWN: LB
DRAWING NO: FATRA MF-34		REVISION: -

Single Ply Membrane Details
Mechanically Fixed System
Fascia drip trim detail

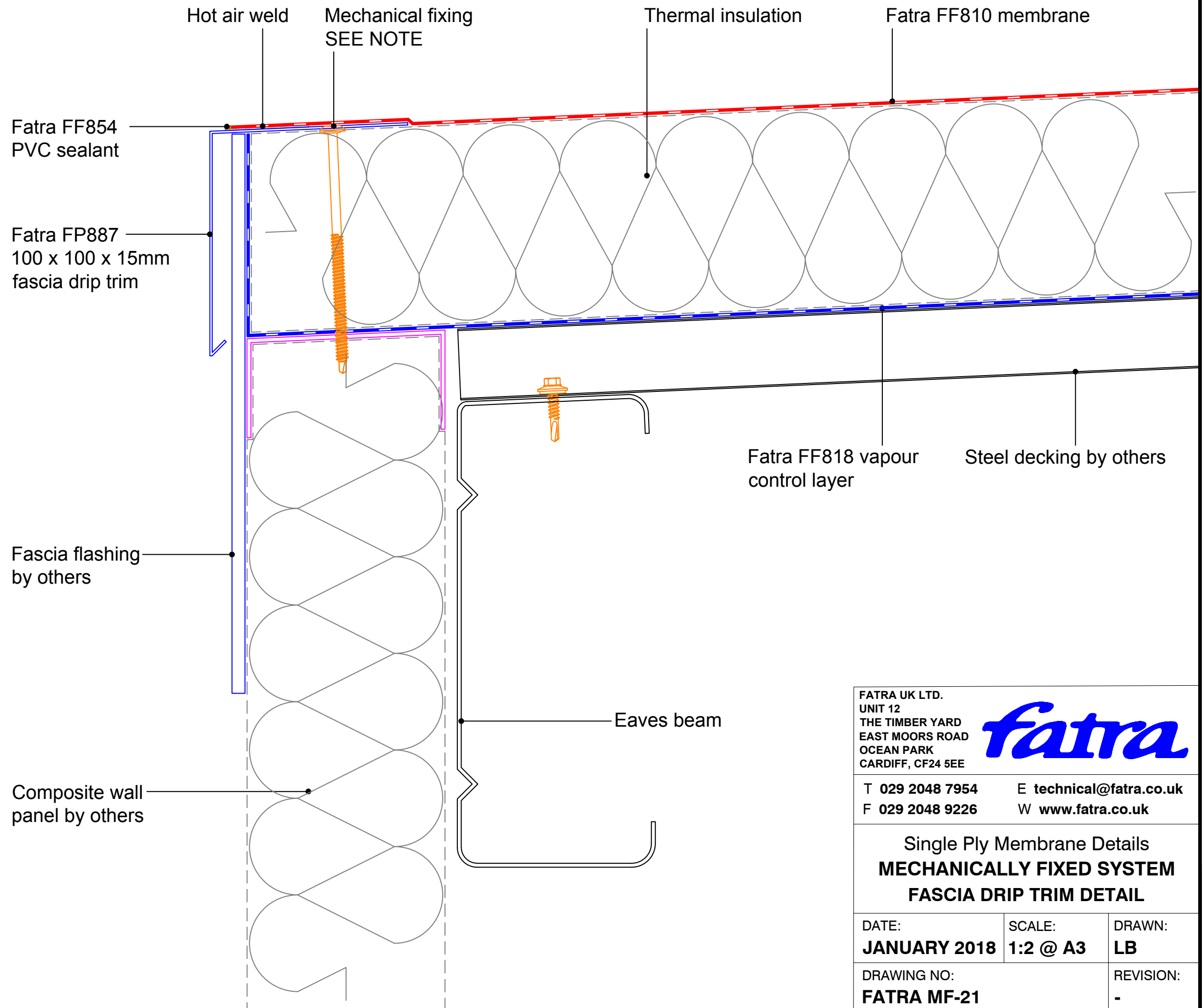

MECHANICAL FIXINGS:-

Selection of fixings:-
 Deck - Metal/Timber/plywood
 FBS-5.8 fasteners
 Metal deck 15mm penetration to underside
 Timber deck 12mm penetration to underside

Deck - Concrete
 FHD-6.1 fasteners
 Concrete deck 25mm embedment

FATRA UK LTD. UNIT 12 THE TIMBER YARD EAST MOORS ROAD OCEAN PARK CARDIFF, CF24 5EE		
T 029 2048 7954 F 029 2048 9226	E technical@fatra.co.uk W www.fatra.co.uk	
Single Ply Membrane Details MECHANICALLY FIXED SYSTEM FASCIA DRIP TRIM DETAIL		
DATE: JANUARY 2018	SCALE: 1:2 @ A3	DRAWN: LB
DRAWING NO: FATRA MF-21		REVISION: -

Single Ply Membrane Details
Mechanically Fixed System
Filleted fascia drip trim detail

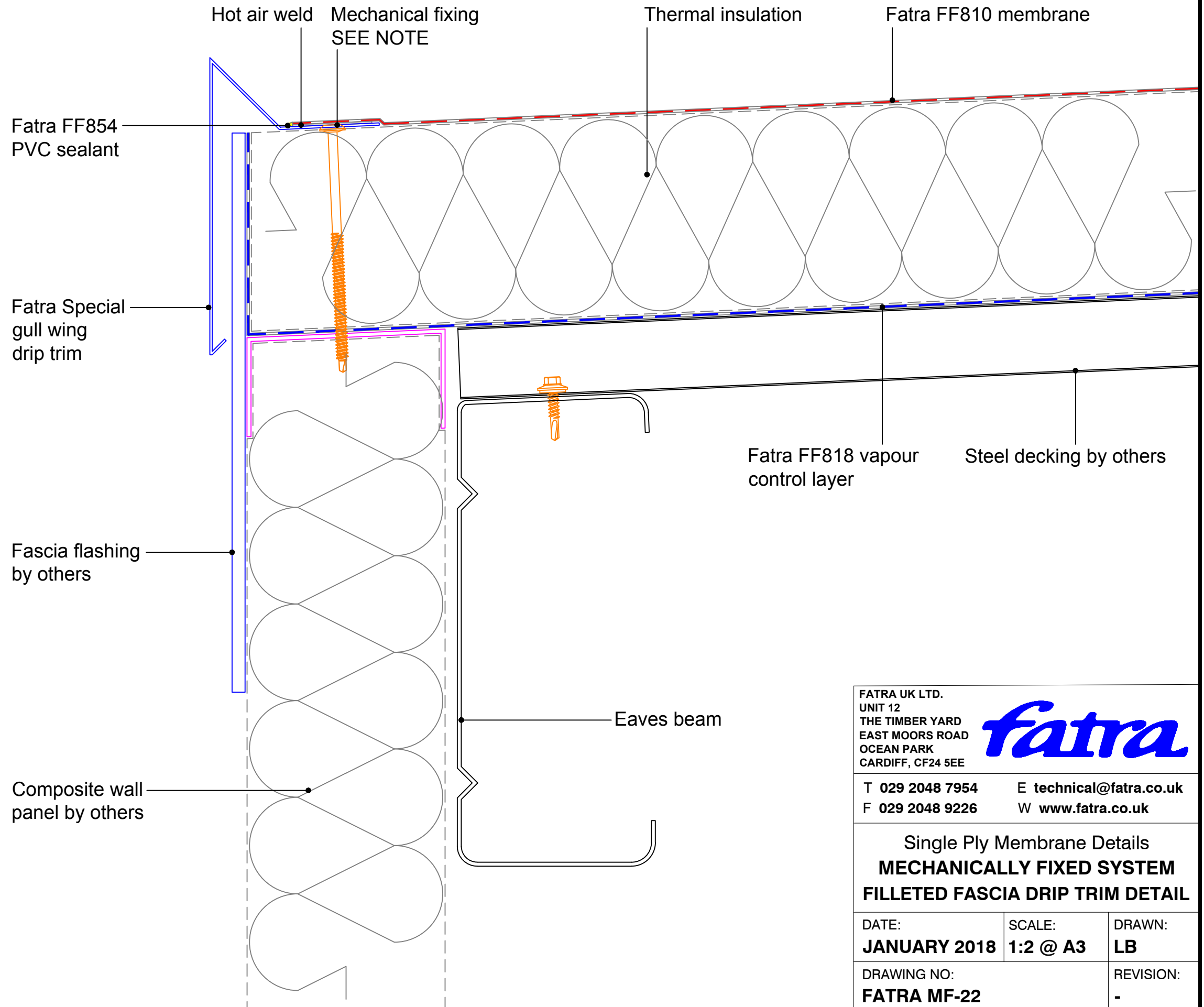

MECHANICAL FIXINGS:-

Selection of fixings:-
 Deck - Metal/Timber/plywood
 FBS-5.8 fasteners
 Metal deck 15mm penetration to underside
 Timber deck 12mm penetration to underside

Deck - Concrete
 FHD-6.1 fasteners
 Concrete deck 25mm embedment

FATRA UK LTD. UNIT 12 THE TIMBER YARD EAST MOORS ROAD OCEAN PARK CARDIFF, CF24 5EE		
		
T 029 2048 7954	E technical@fatra.co.uk	
F 029 2048 9226	W www.fatra.co.uk	
Single Ply Membrane Details MECHANICALLY FIXED SYSTEM FILLETED FASCIA DRIP TRIM DETAIL		
DATE: JANUARY 2018	SCALE: 1:2 @ A3	DRAWN: LB
DRAWING NO: FATRA MF-22		REVISION: -

Single Ply Membrane Details
Mechanically Fixed System
Soil & vent pipe detail

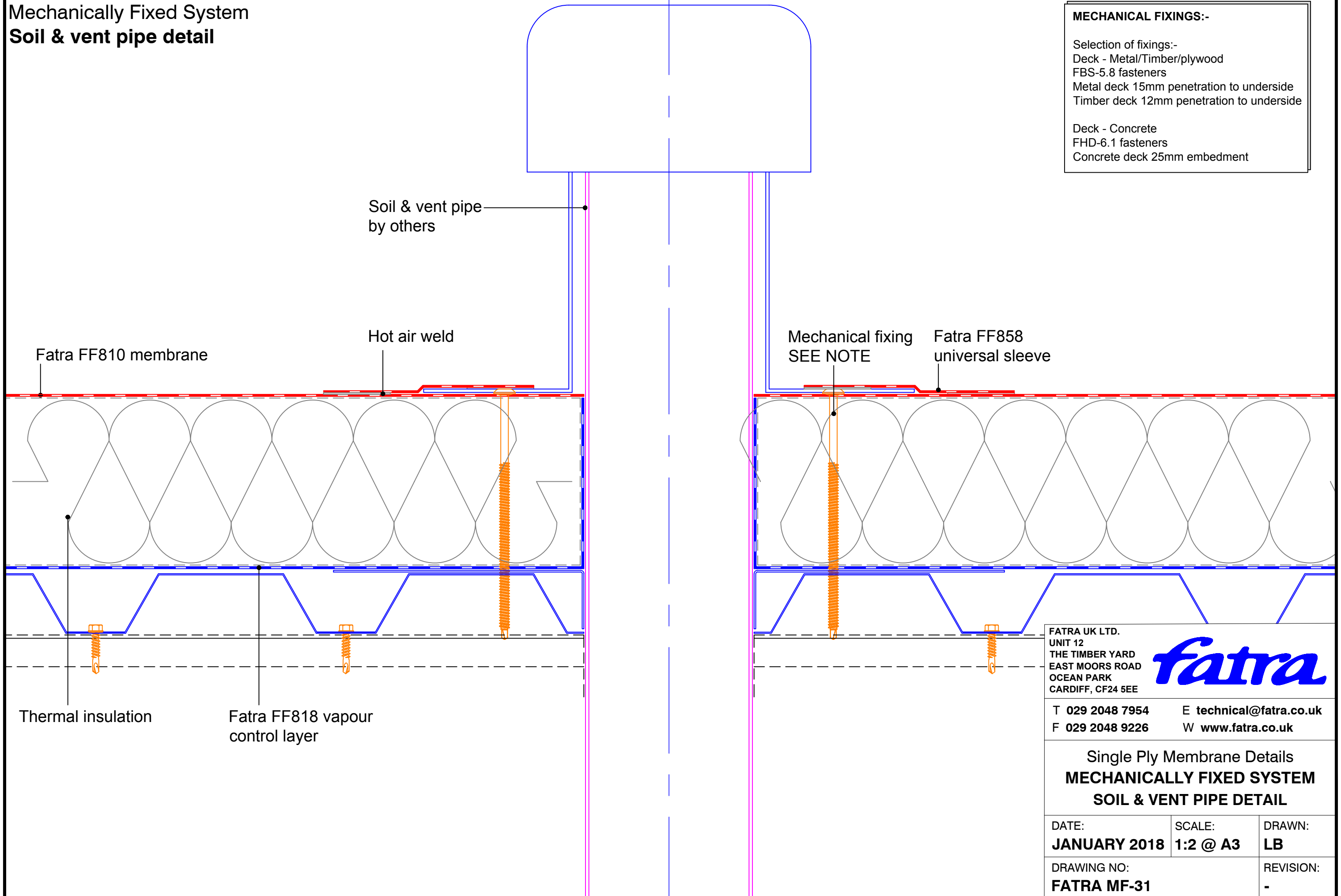

MECHANICAL FIXINGS:-

Selection of fixings:-
 Deck - Metal/Timber/plywood
 FBS-5.8 fasteners
 Metal deck 15mm penetration to underside
 Timber deck 12mm penetration to underside

Deck - Concrete
 FHD-6.1 fasteners
 Concrete deck 25mm embedment

FATRA UK LTD.
 UNIT 12
 THE TIMBER YARD
 EAST MOORS ROAD
 OCEAN PARK
 CARDIFF, CF24 5EE

fatra

T 029 2048 7954 E technical@fatra.co.uk
 F 029 2048 9226 W www.fatra.co.uk

Single Ply Membrane Details MECHANICALLY FIXED SYSTEM SOIL & VENT PIPE DETAIL		
DATE: JANUARY 2018	SCALE: 1:2 @ A3	DRAWN: LB
DRAWING NO: FATRA MF-31		REVISION: -

Single Ply Membrane Details
Mechanically Fixed System
Section through concrete deck

MECHANICAL FIXINGS:-

Selection of fixings:-
 Deck - Metal/Timber/plywood
 FBS-5.8 fasteners
 Metal deck 15mm penetration to underside
 Timber deck 12mm penetration to underside

Deck - Concrete
 FHD-6.1 fasteners
 Concrete deck 25mm embedment

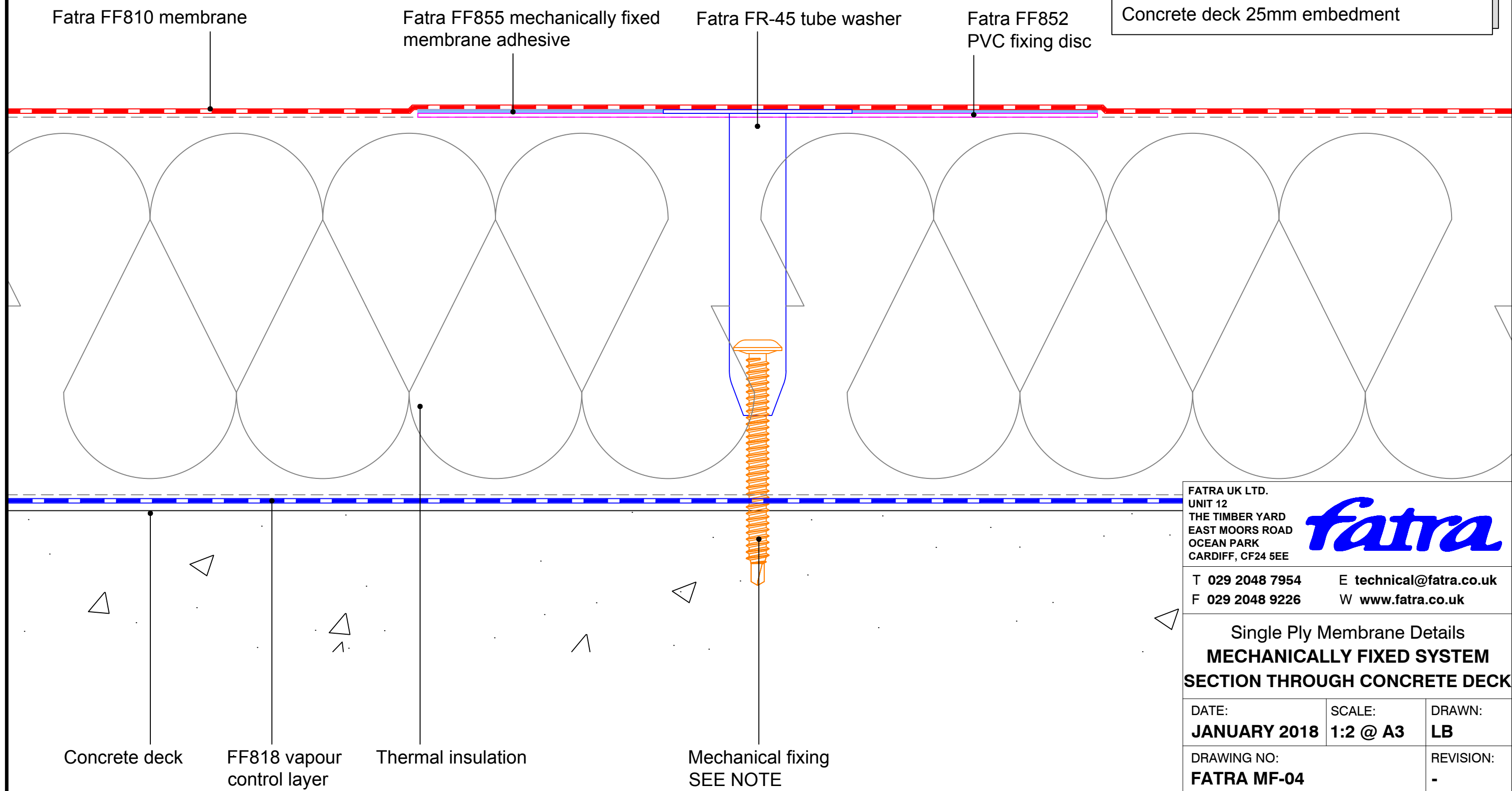

FATRA UK LTD.
 UNIT 12
 THE TIMBER YARD
 EAST MOORS ROAD
 OCEAN PARK
 CARDIFF, CF24 5EE



T 029 2048 7954 E technical@fatra.co.uk
 F 029 2048 9226 W www.fatra.co.uk

Single Ply Membrane Details
MECHANICALLY FIXED SYSTEM
SECTION THROUGH CONCRETE DECK

DATE: JANUARY 2018	SCALE: 1:2 @ A3	DRAWN: LB
DRAWING NO: FATRA MF-04		REVISION: -

Single Ply Membrane Details
 Mechanically Fixed System
 Section through plywood deck - B

MECHANICAL FIXINGS:-

Selection of fixings:-
 Deck - Metal/Timber/plywood
 FBS-5.8 fasteners
 Metal deck 15mm penetration to underside
 Timber deck 12mm penetration to underside

Deck - Concrete
 FHD-6.1 fasteners
 Concrete deck 25mm embedment

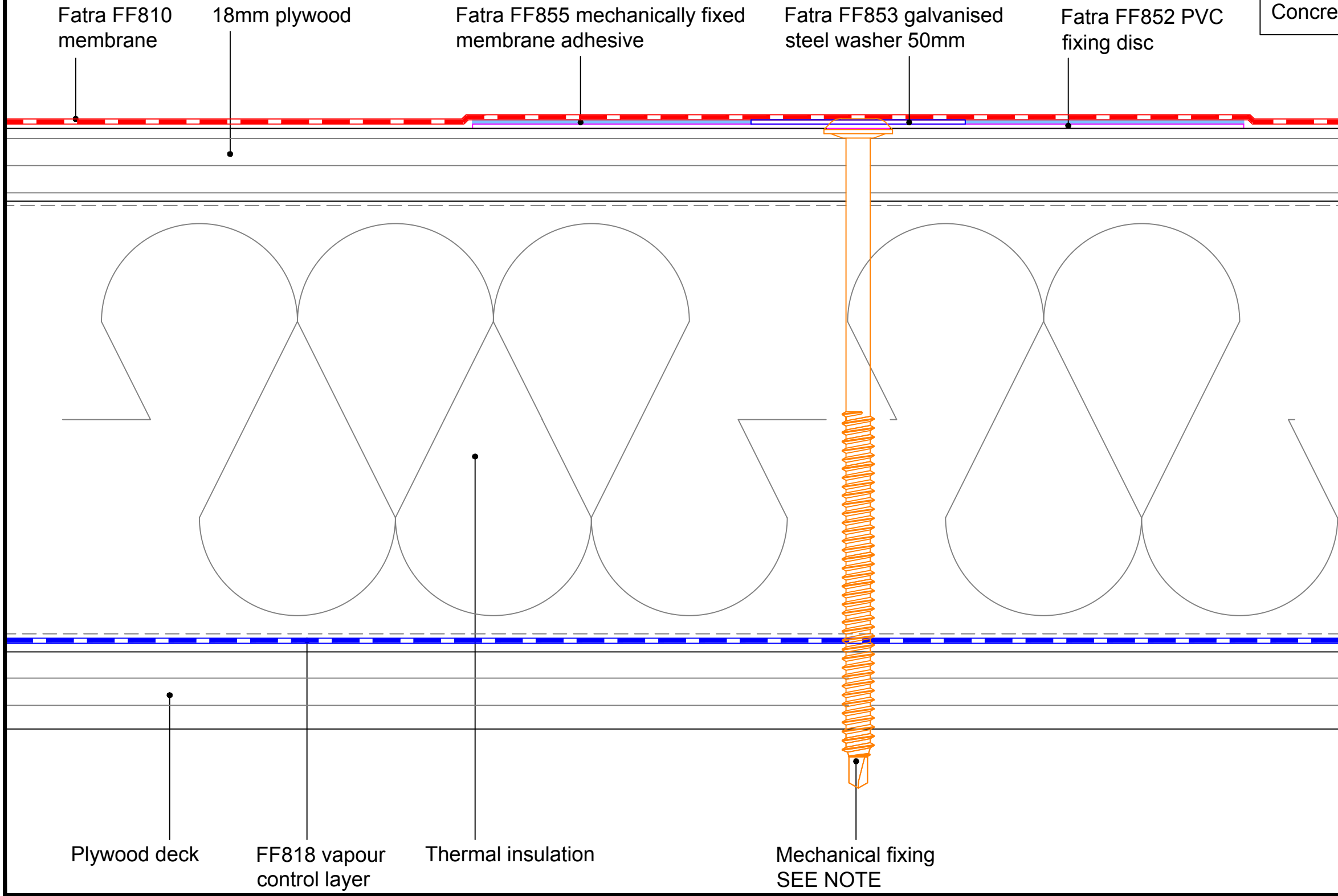

FATRA UK LTD.
 UNIT 12
 THE TIMBER YARD
 EAST MOORS ROAD
 OCEAN PARK
 CARDIFF, CF24 5EE



T 029 2048 7954 E technical@fatra.co.uk
 F 029 2048 9226 W www.fatra.co.uk

Single Ply Membrane Details
MECHANICALLY FIXED SYSTEM
SECTION THROUGH PLYWOOD DECK B

DATE: JANUARY 2018	SCALE: 1:1 @ A3	DRAWN: LB
DRAWING NO: FATRA MF-03		REVISION: -

Plywood deck FF818 vapour control layer Thermal insulation Mechanical fixing SEE NOTE

Single Ply Membrane Details
 Mechanically Fixed System
 Section through metal deck

MECHANICAL FIXINGS:-

Selection of fixings:-
 Deck - Metal/Timber/plywood
 FBS-5.8 fasteners
 Metal deck 15mm penetration to underside
 Timber deck 12mm penetration to underside

Deck - Concrete
 FHD-6.1 fasteners
 Concrete deck 25mm embedment

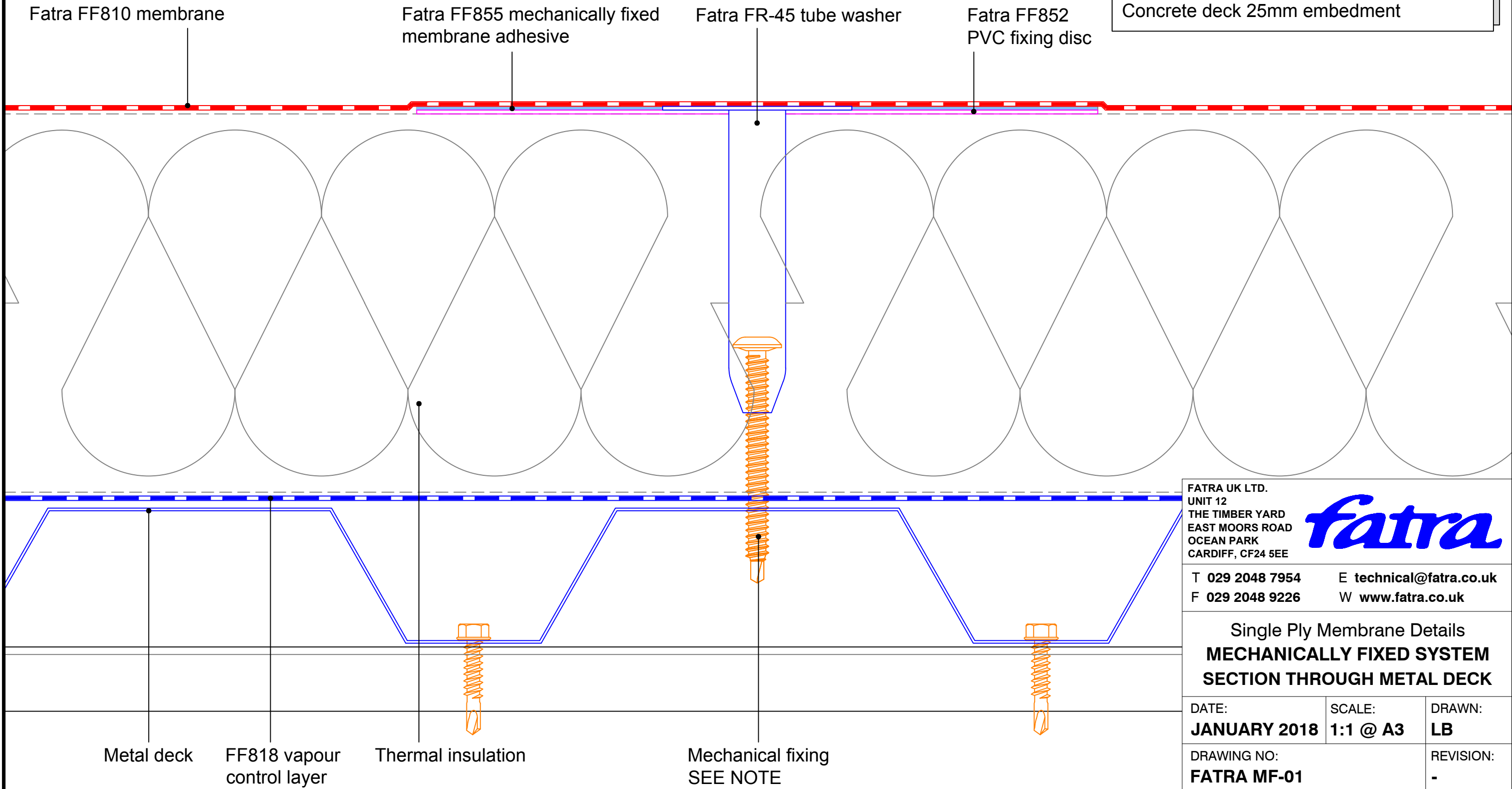

FATRA UK LTD.
 UNIT 12
 THE TIMBER YARD
 EAST MOORS ROAD
 OCEAN PARK
 CARDIFF, CF24 5EE

fatra

T 029 2048 7954 E technical@fatra.co.uk
 F 029 2048 9226 W www.fatra.co.uk

Single Ply Membrane Details
MECHANICALLY FIXED SYSTEM
SECTION THROUGH METAL DECK

DATE: JANUARY 2018	SCALE: 1:1 @ A3	DRAWN: LB
DRAWING NO: FATRA MF-01		REVISION: -

Single Ply Membrane Details
 Mechanically Fixed System
 Section through plywood deck - A

MECHANICAL FIXINGS:-

Selection of fixings:-
 Deck - Metal/Timber/plywood
 FBS-5.8 fasteners
 Metal deck 15mm penetration to underside
 Timber deck 12mm penetration to underside

Deck - Concrete
 FHD-6.1 fasteners
 Concrete deck 25mm embedment

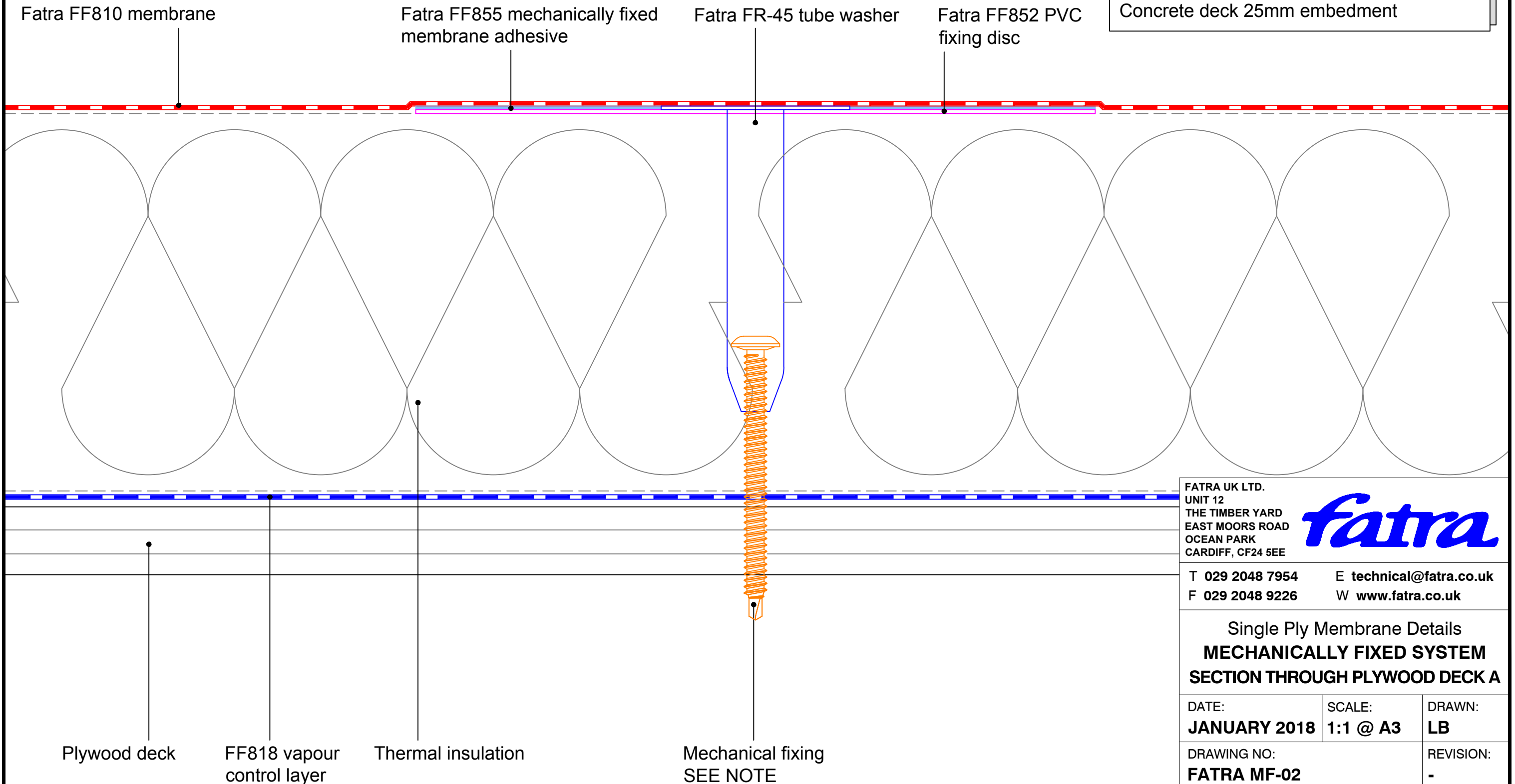

FATRA UK LTD.
 UNIT 12
 THE TIMBER YARD
 EAST MOORS ROAD
 OCEAN PARK
 CARDIFF, CF24 5EE



T 029 2048 7954 E technical@fatra.co.uk
 F 029 2048 9226 W www.fatra.co.uk

Single Ply Membrane Details
MECHANICALLY FIXED SYSTEM
SECTION THROUGH PLYWOOD DECK A

DATE: JANUARY 2018	SCALE: 1:1 @ A3	DRAWN: LB
DRAWING NO: FATRA MF-02		REVISION: -

Single Ply Membrane Details
Mechanically Fixed System
Handrail post detail

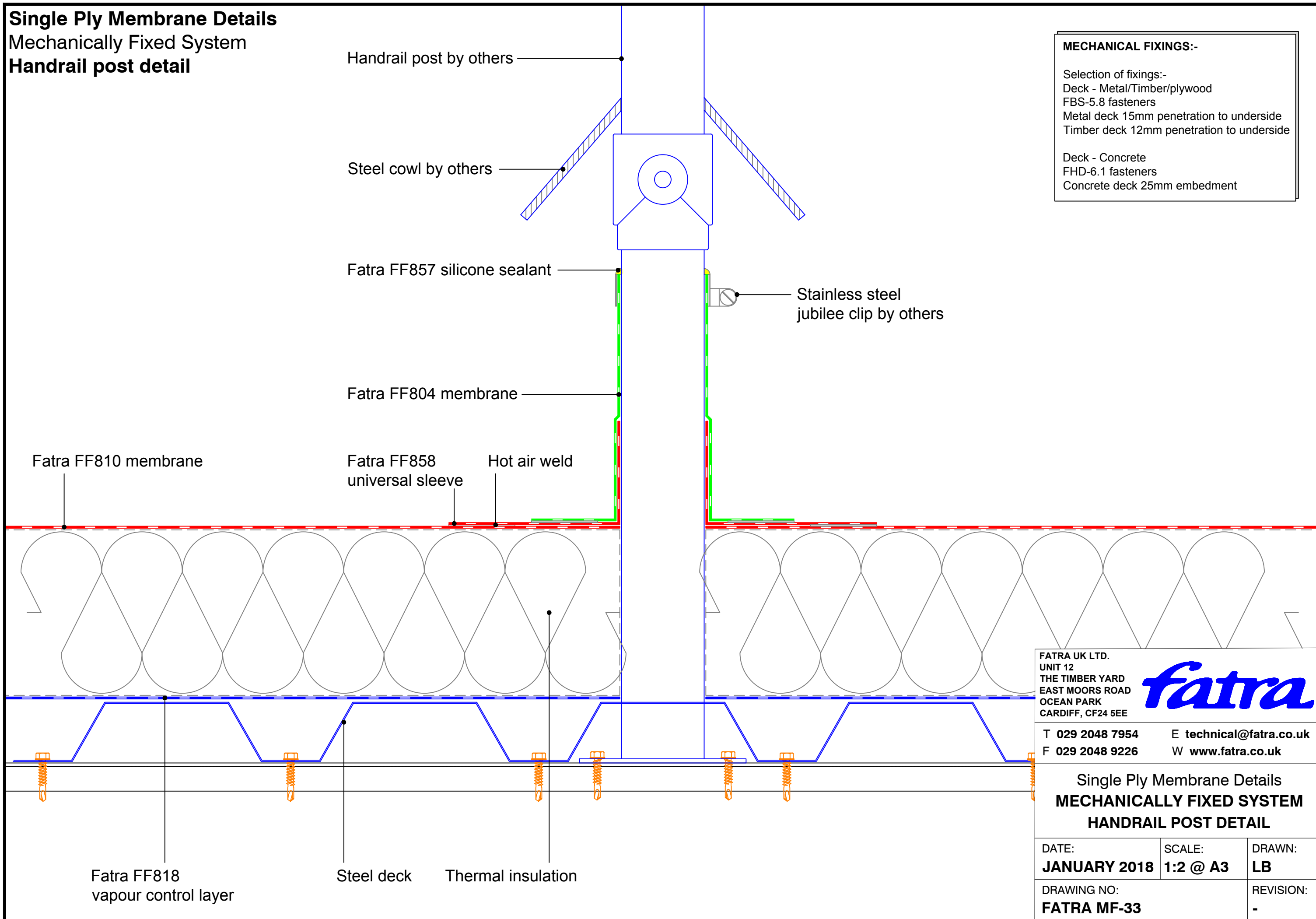

MECHANICAL FIXINGS:-

Selection of fixings:-
 Deck - Metal/Timber/plywood
 FBS-5.8 fasteners
 Metal deck 15mm penetration to underside
 Timber deck 12mm penetration to underside

Deck - Concrete
 FHD-6.1 fasteners
 Concrete deck 25mm embedment

FATRA UK LTD.
 UNIT 12
 THE TIMBER YARD
 EAST MOORS ROAD
 OCEAN PARK
 CARDIFF, CF24 5EE

fatra

T 029 2048 7954 E technical@fatra.co.uk
 F 029 2048 9226 W www.fatra.co.uk

Single Ply Membrane Details
MECHANICALLY FIXED SYSTEM
HANDRAIL POST DETAIL

DATE: JANUARY 2018	SCALE: 1:2 @ A3	DRAWN: LB
DRAWING NO: FATRA MF-33		REVISION: -

Single Ply Membrane Details
Mechanically fixed insulation, fully adhered membrane
Hybrid detail

MECHANICAL FIXINGS:-

Selection of fixings:-
 Deck - Metal/Timber/plywood
 FBS-5.8 fasteners
 Metal deck 15mm penetration to underside
 Timber deck 12mm penetration to underside

Deck - Concrete
 FHD-6.1 fasteners
 Concrete deck 25mm embedment

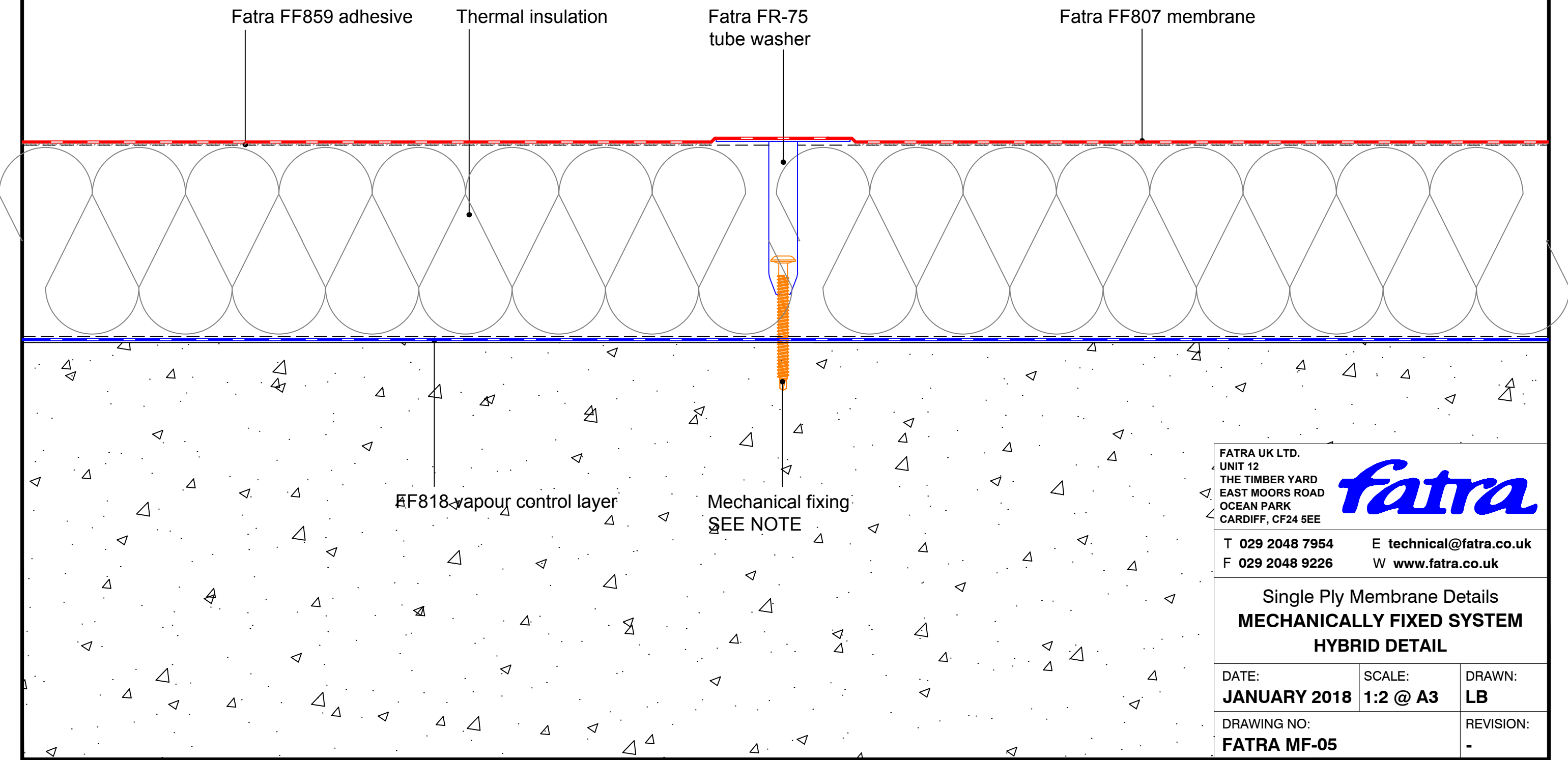

FATRA UK LTD. UNIT 12 THE TIMBER YARD EAST MOORS ROAD OCEAN PARK CARDIFF, CF24 5EE		
T 029 2048 7954 F 029 2048 9226	E technical@fatra.co.uk W www.fatra.co.uk	
Single Ply Membrane Details MECHANICALLY FIXED SYSTEM HYBRID DETAIL		
DATE: JANUARY 2018	SCALE: 1:2 @ A3	DRAWN: LB
DRAWING NO: FATRA MF-05		REVISION: -

Single Ply Membrane Details
Mechanically Fixed System
Column penetration - isometric

MECHANICAL FIXINGS:-

Selection of fixings:-
 Deck - Metal/Timber/plywood
 FBS-5.8 fasteners
 Metal deck 15mm penetration to underside
 Timber deck 12mm penetration to underside

Deck - Concrete
 FHD-6.1 fasteners
 Concrete deck 25mm embedment

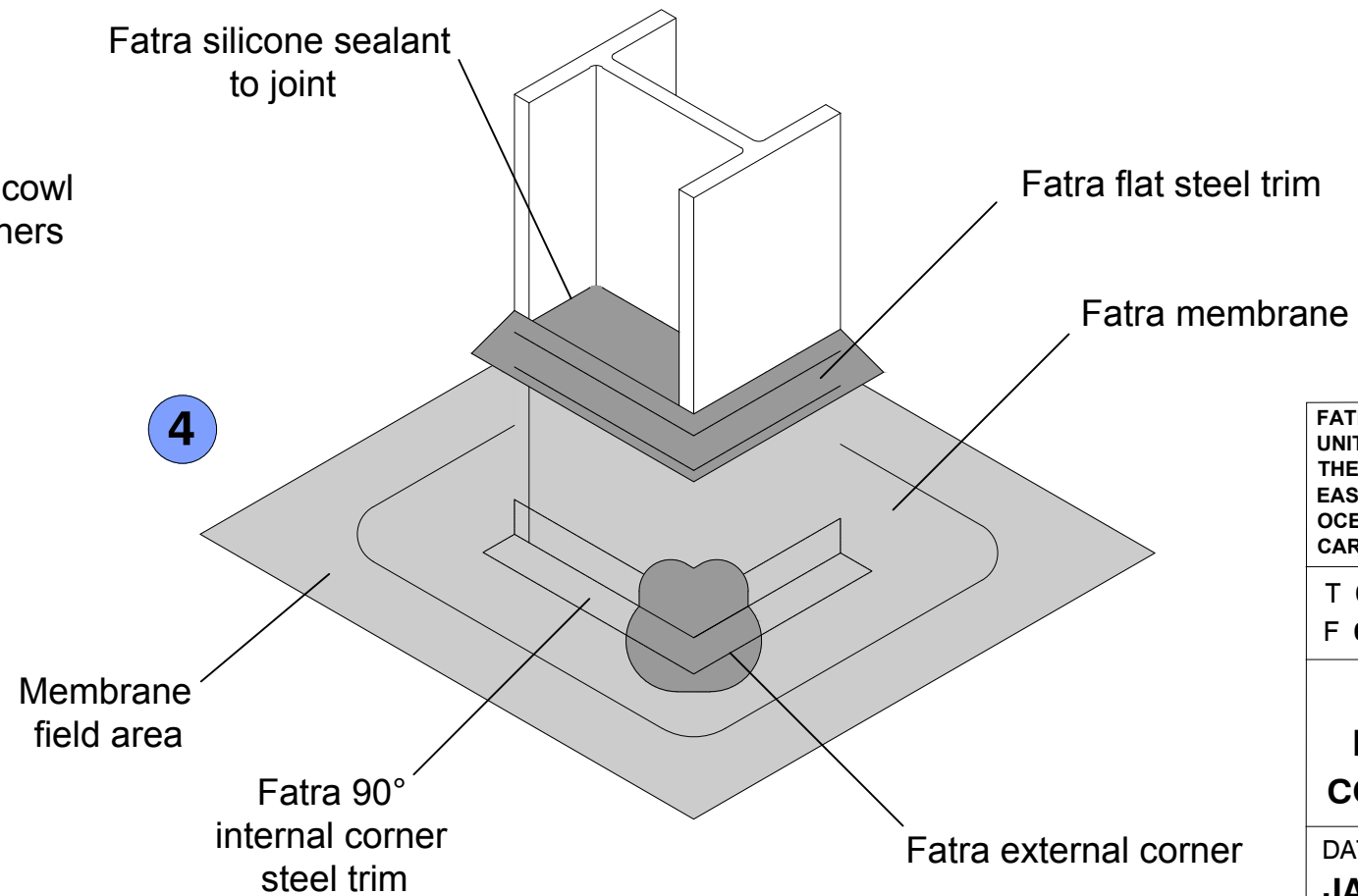
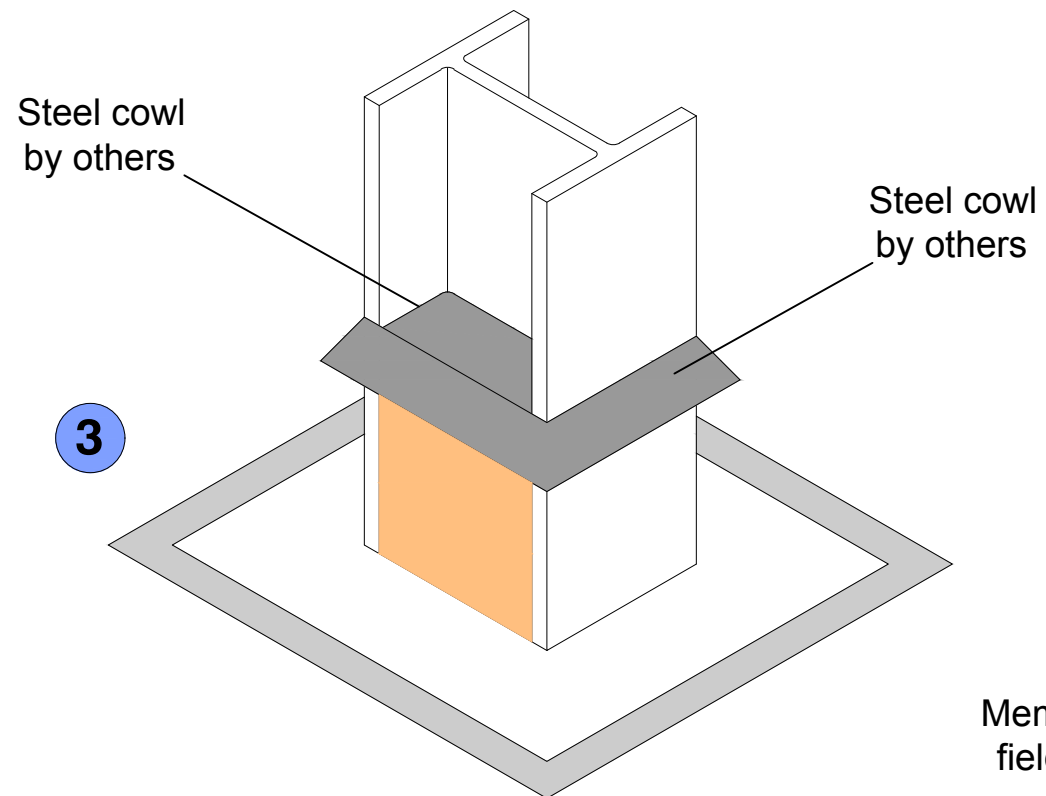
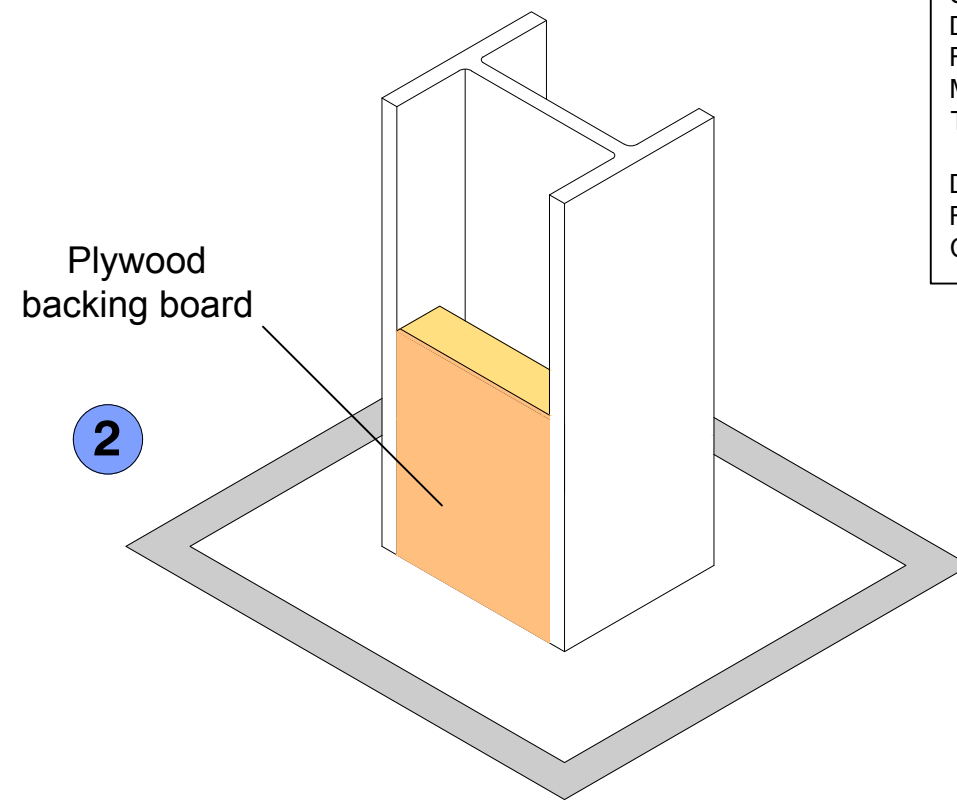
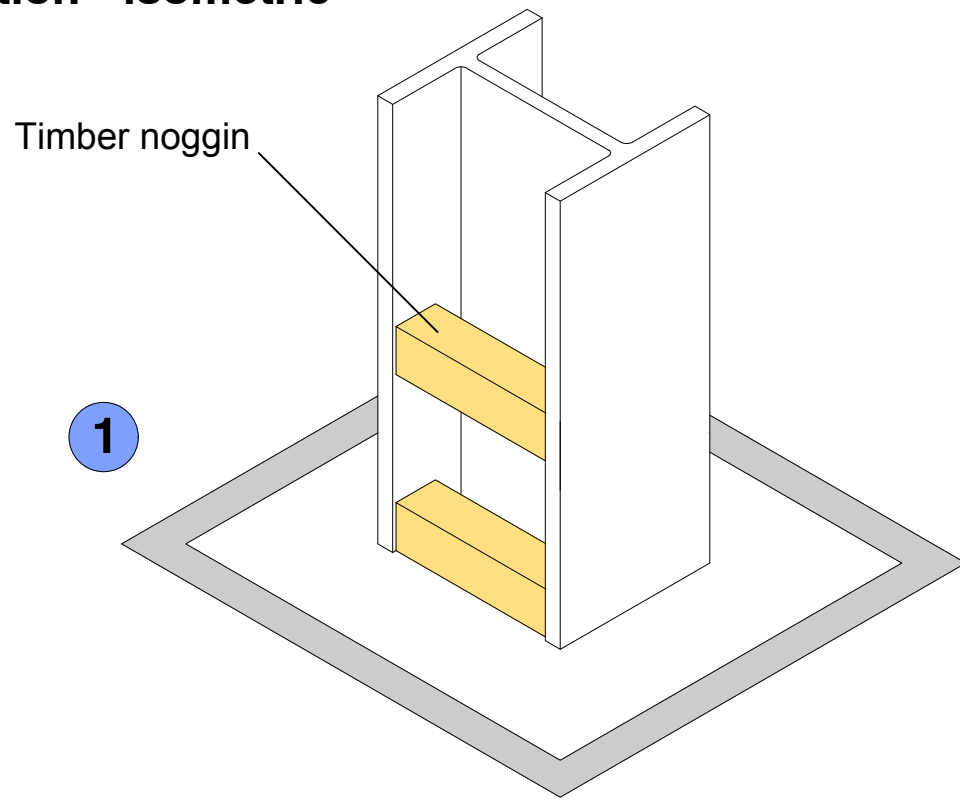

FATRA UK LTD.
 UNIT 12
 THE TIMBER YARD
 EAST MOORS ROAD
 OCEAN PARK
 CARDIFF, CF24 5EE



T 029 2048 7954 E technical@fatra.co.uk
 F 029 2048 9226 W www.fatra.co.uk

Single Ply Membrane Details
MECHANICALLY FIXED SYSTEM
COLUMN PENETRATION ISOMETRIC

DATE: JANUARY 2018	SCALE: 1:2 @ A3	DRAWN: LB
DRAWING NO: FATRA MF-36		REVISION: -

Single Ply Membrane Details

Mechanically Fixed System

Insulated parapet detail

MECHANICAL FIXINGS:-

Selection of fixings:-
 Deck - Metal/Timber/plywood
 FBS-5.8 fasteners
 Metal deck 15mm penetration to underside
 Timber deck 12mm penetration to underside

Deck - Concrete
 FHD-6.1 fasteners
 Concrete deck 25mm embedment

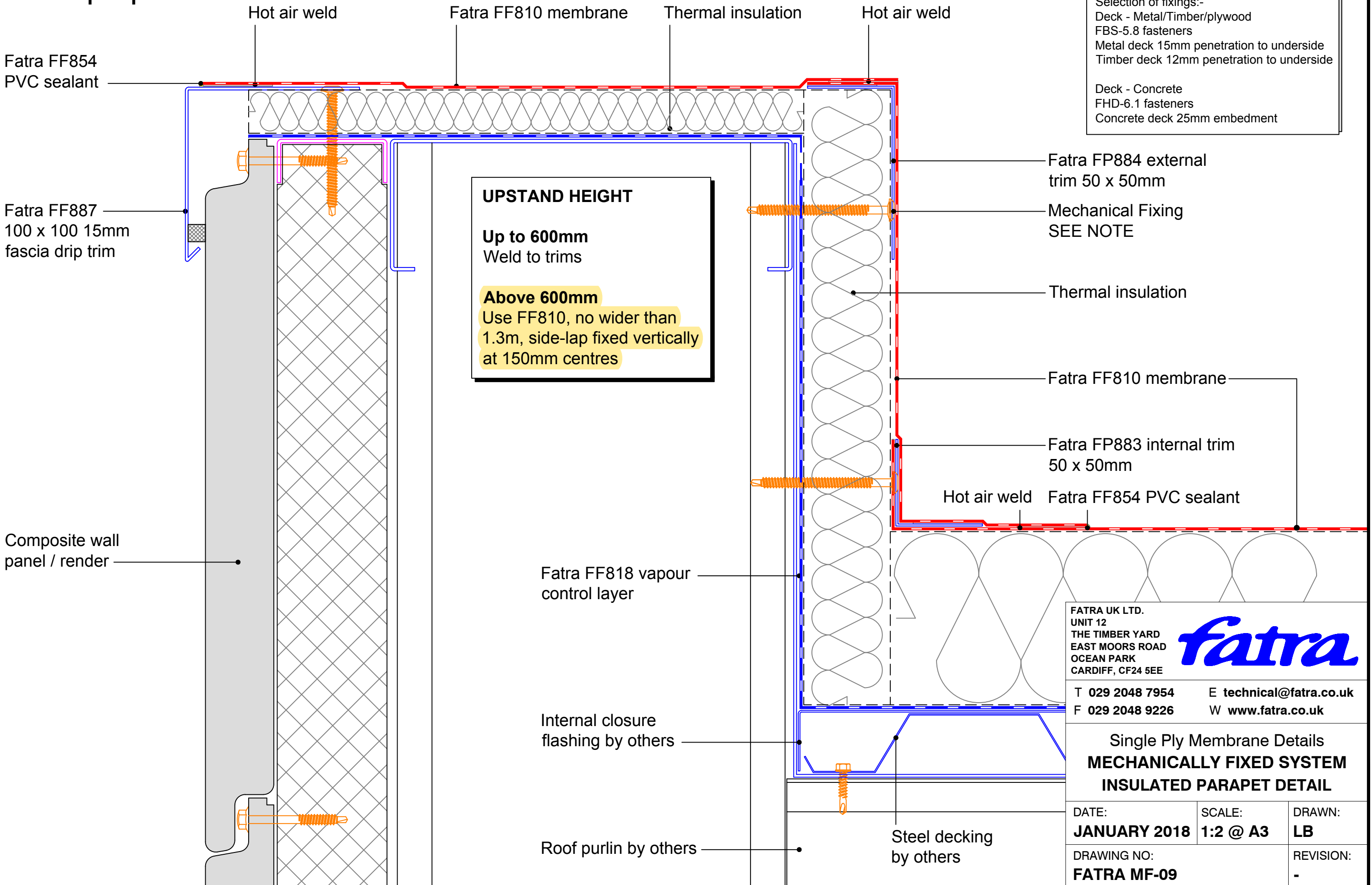

UPSTAND HEIGHT
 Up to 600mm
 Weld to trims
 Above 600mm
 Use FF810, no wider than
 1.3m, side-lap fixed vertically
 at 150mm centres

FATRA UK LTD.
 UNIT 12
 THE TIMBER YARD
 EAST MOORS ROAD
 OCEAN PARK
 CARDIFF, CF24 5EE



T 029 2048 7954 E technical@fatra.co.uk
 F 029 2048 9226 W www.fatra.co.uk

Single Ply Membrane Details
MECHANICALLY FIXED SYSTEM
INSULATED PARAPET DETAIL

DATE: JANUARY 2018	SCALE: 1:2 @ A3	DRAWN: LB
DRAWING NO: FATRA MF-09		REVISION: -

Single Ply Membrane Details
Mechanically Fixed System
Gutter detail

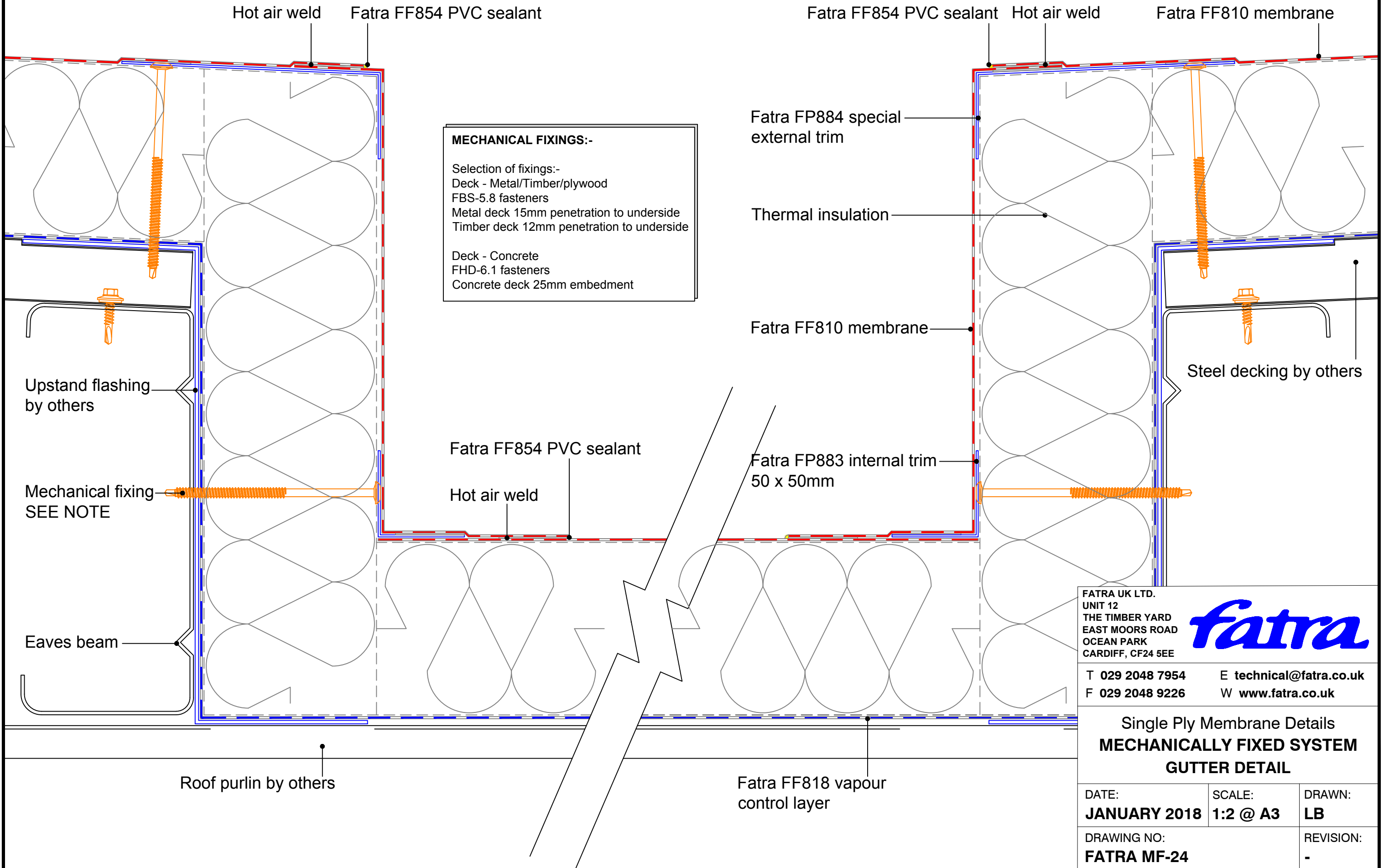

FATRA UK LTD.
 UNIT 12
 THE TIMBER YARD
 EAST MOORS ROAD
 OCEAN PARK
 CARDIFF, CF24 5EE



T 029 2048 7954 E technical@fatra.co.uk
 F 029 2048 9226 W www.fatra.co.uk

Single Ply Membrane Details
MECHANICALLY FIXED SYSTEM
GUTTER DETAIL

DATE: JANUARY 2018	SCALE: 1:2 @ A3	DRAWN: LB
DRAWING NO: FATRA MF-24		REVISION: -

Single Ply Membrane Details
Mechanically Fixed System
Membrane to asphalt abutment

MECHANICAL FIXINGS:-

Selection of fixings:-
 Deck - Metal/Timber/plywood
 FBS-5.8 fasteners
 Metal deck 15mm penetration to underside
 Timber deck 12mm penetration to underside

Deck - Concrete
 FHD-6.1 fasteners
 Concrete deck 25mm embedment

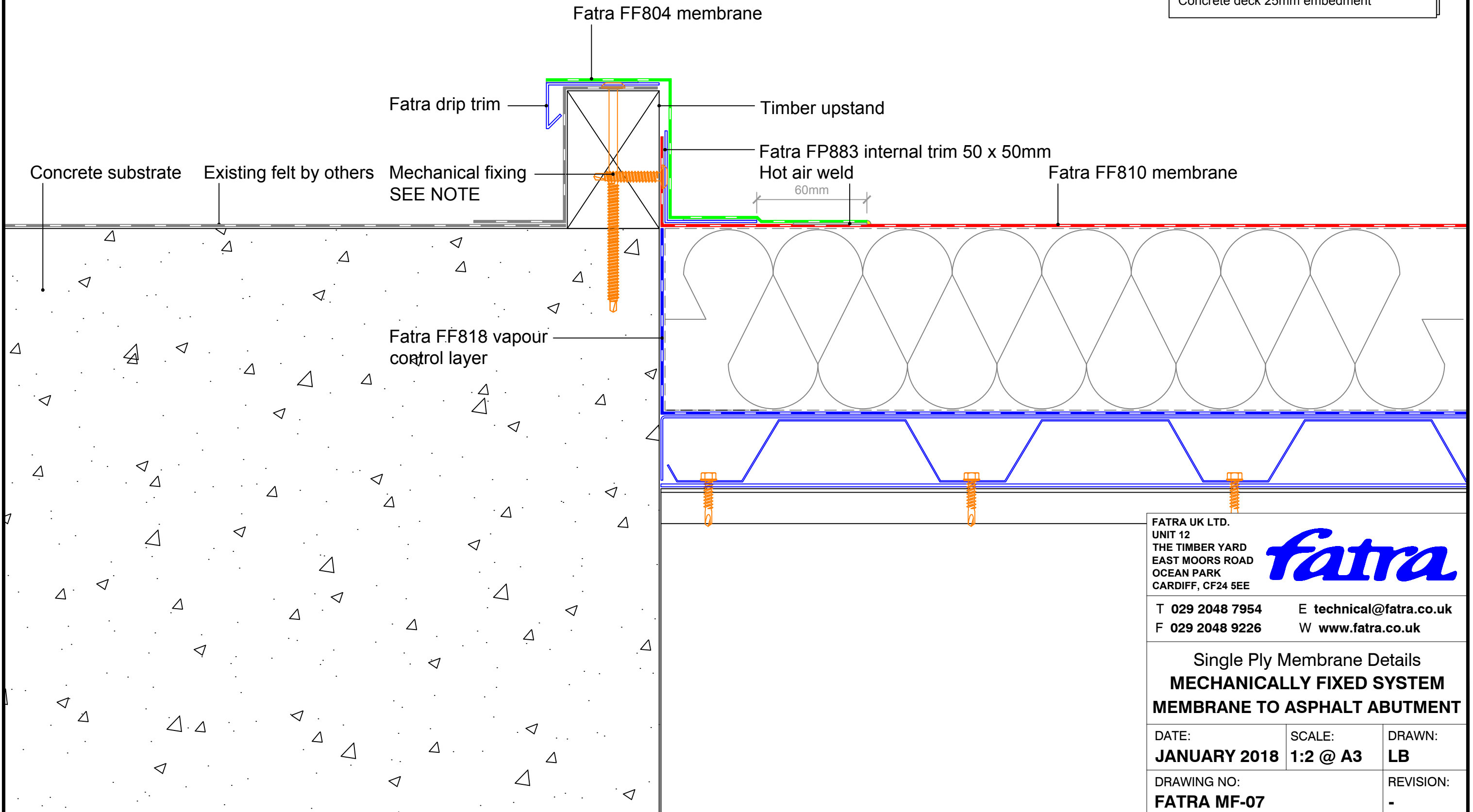

FATRA UK LTD.
 UNIT 12
 THE TIMBER YARD
 EAST MOORS ROAD
 OCEAN PARK
 CARDIFF, CF24 5EE



T 029 2048 7954 E technical@fatra.co.uk
 F 029 2048 9226 W www.fatra.co.uk

Single Ply Membrane Details
MECHANICALLY FIXED SYSTEM
MEMBRANE TO ASPHALT ABUTMENT

DATE: JANUARY 2018	SCALE: 1:2 @ A3	DRAWN: LB
DRAWING NO: FATRA MF-07		REVISION: -

Single Ply Membrane Details

Mechanically Fixed System

Mansard to tiled roof

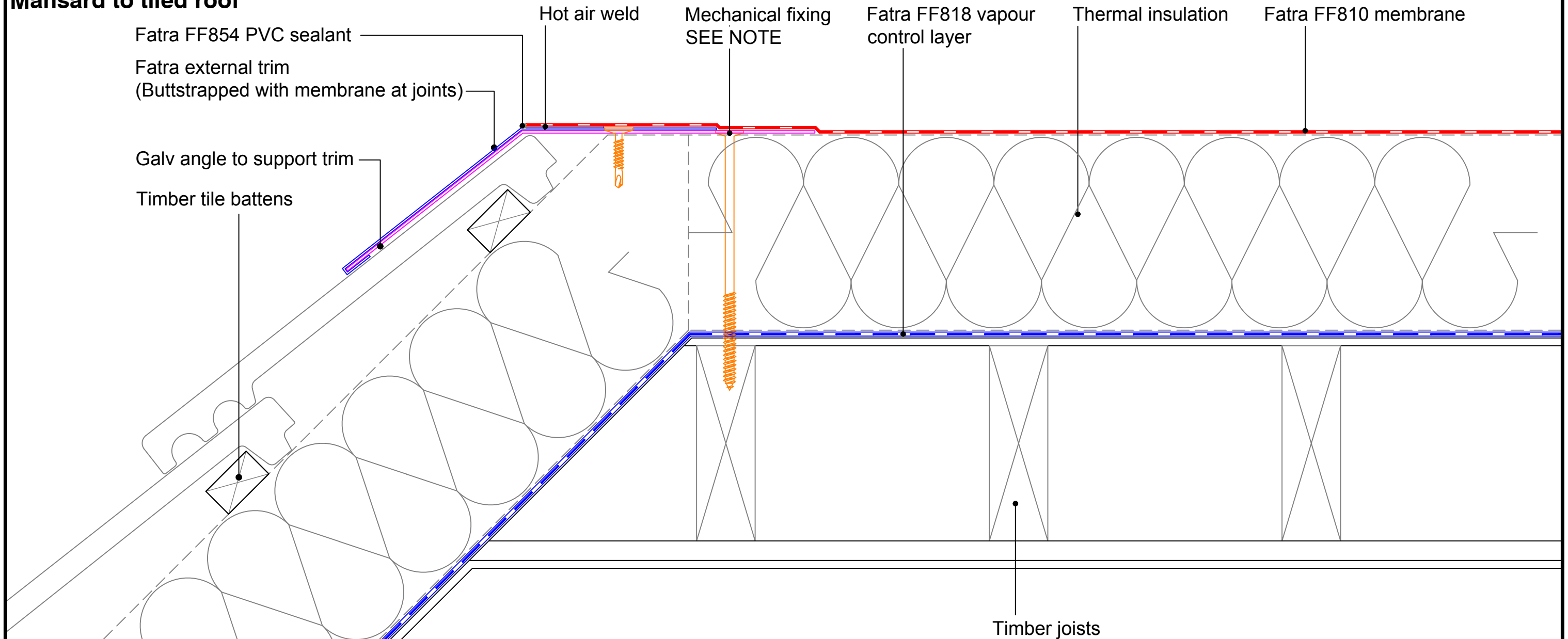

MECHANICAL FIXINGS:-

Selection of fixings:-
 Deck - Metal/Timber/plywood
 FBS-5.8 fasteners
 Metal deck 15mm penetration to underside
 Timber deck 12mm penetration to underside

Deck - Concrete
 FHD-6.1 fasteners
 Concrete deck 25mm embedment

FATRA UK LTD.
 UNIT 12
 THE TIMBER YARD
 EAST MOORS ROAD
 OCEAN PARK
 CARDIFF, CF24 5EE



T 029 2048 7954 E technical@fatra.co.uk
 F 029 2048 9226 W www.fatra.co.uk

Single Ply Membrane Details
MECHANICALLY FIXED SYSTEM
MANSARD TO TILED ROOF

DATE: JANUARY 2018	SCALE: 1:2 @ A3	DRAWN: LB
------------------------------	---------------------------	---------------------

DRAWING NO: FATRA MF-45	REVISION: -
-----------------------------------	-----------------------

Single Ply Membrane Details

Mechanically Fixed system

Membrane coping detail

MECHANICAL FIXINGS:-

Selection of fixings:-
 Deck - Metal/Timber/plywood
 FBS-5.8 fasteners
 Metal deck 15mm penetration to underside
 Timber deck 12mm penetration to underside

Deck - Concrete
 FHD-6.1 fasteners
 Concrete deck 25mm embedment

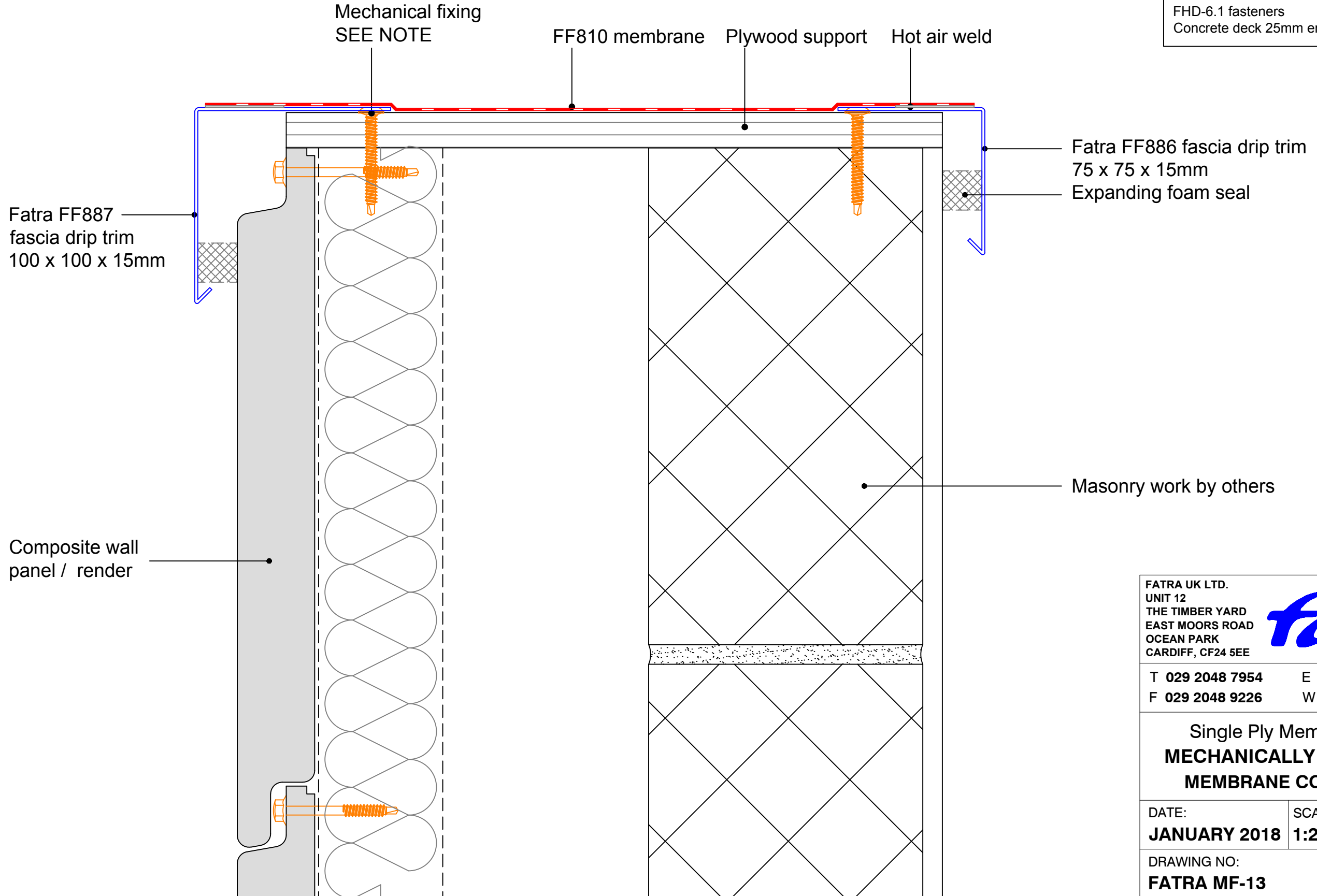

FATRA UK LTD.
 UNIT 12
 THE TIMBER YARD
 EAST MOORS ROAD
 OCEAN PARK
 CARDIFF, CF24 5EE



T 029 2048 7954 E technical@fatra.co.uk
 F 029 2048 9226 W www.fatra.co.uk

Single Ply Membrane Details
MECHANICALLY FIXED SYSTEM
MEMBRANE COPING DETAIL

DATE: JANUARY 2018	SCALE: 1:2 @ A3	DRAWN: LB
------------------------------	---------------------------	---------------------

DRAWING NO: FATRA MF-13	REVISION: -
-----------------------------------	----------------

Single Ply Membrane Details
Mechanically Fixed System
Parapet detail with handrail

Fatra FF854
PVC sealant

Fatra FF887
100 x 100 15mm
fascia drip trim

Composite wall
panel / render

CONSTRUCTION NOTE:-

To ensure effective waterproofing, the horizontal section of the handrail should be installed first.

After the membrane sleeve has been dressed around the rail, the bracket and vertical rail can be installed.

MECHANICAL FIXINGS:-

Selection of fixings:-
 Deck - Metal/Timber/plywood
 FBS-5.8 fasteners
 Metal deck 15mm penetration to underside
 Timber deck 12mm penetration to underside

Deck - Concrete
 FHD-6.1 fasteners
 Concrete deck 25mm embedment

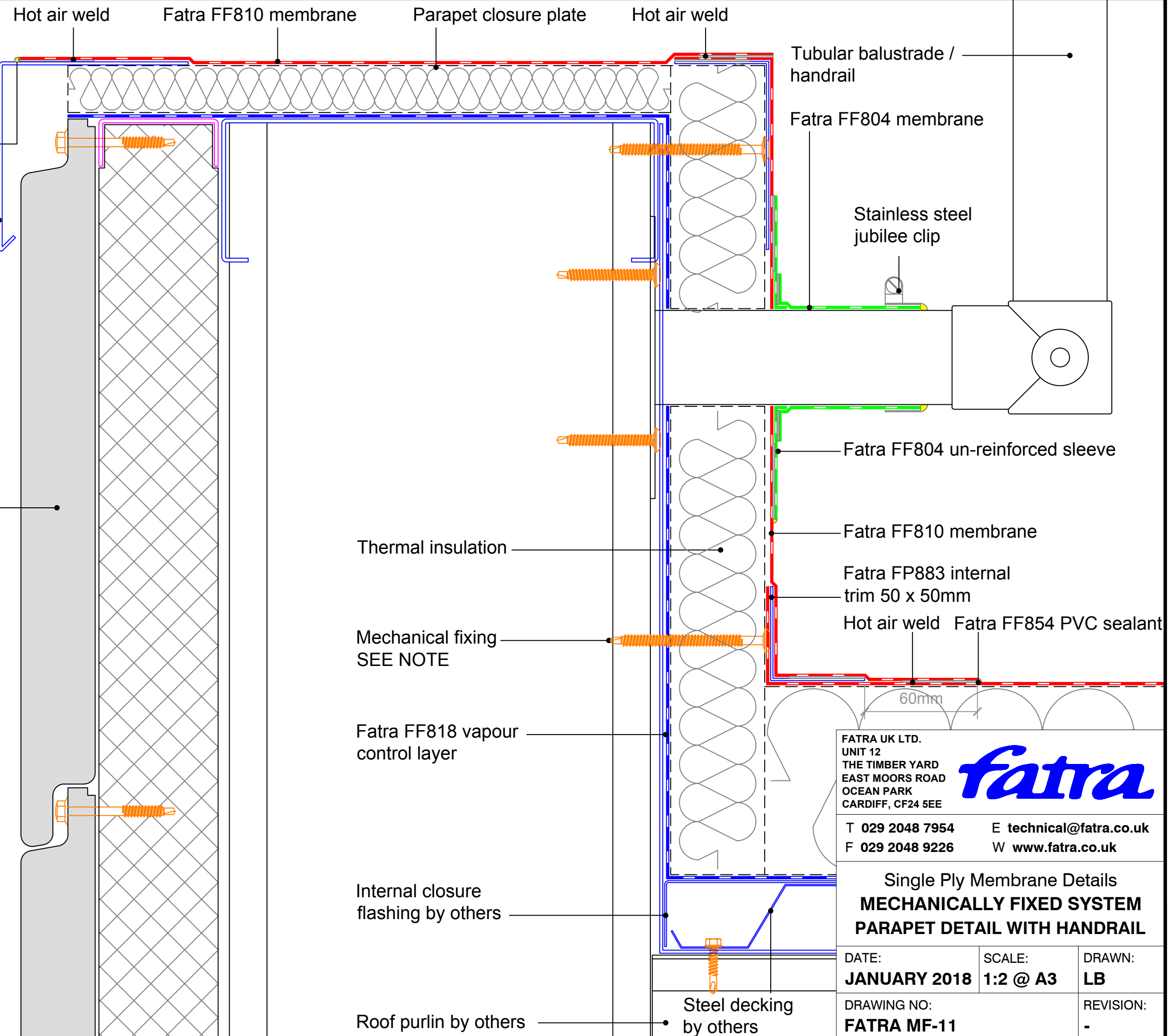

FATRA UK LTD.
 UNIT 12
 THE TIMBER YARD
 EAST MOORS ROAD
 OCEAN PARK
 CARDIFF, CF24 5EE



T 029 2048 7954 E technical@fatra.co.uk
 F 029 2048 9226 W www.fatra.co.uk

Single Ply Membrane Details
MECHANICALLY FIXED SYSTEM
PARAPET DETAIL WITH HANDRAIL

DATE: JANUARY 2018	SCALE: 1:2 @ A3	DRAWN: LB
DRAWING NO: FATRA MF-11		REVISION: -

Single Ply Membrane Details

Mechanically Fixed System

Insulated parapet detail

MECHANICAL FIXINGS:-

Selection of fixings:-
 Deck - Metal/Timber/plywood
 FBS-5.8 fasteners
 Metal deck 15mm penetration to underside
 Timber deck 12mm penetration to underside

 Deck - Concrete
 FHD-6.1 fasteners
 Concrete deck 25mm embedment

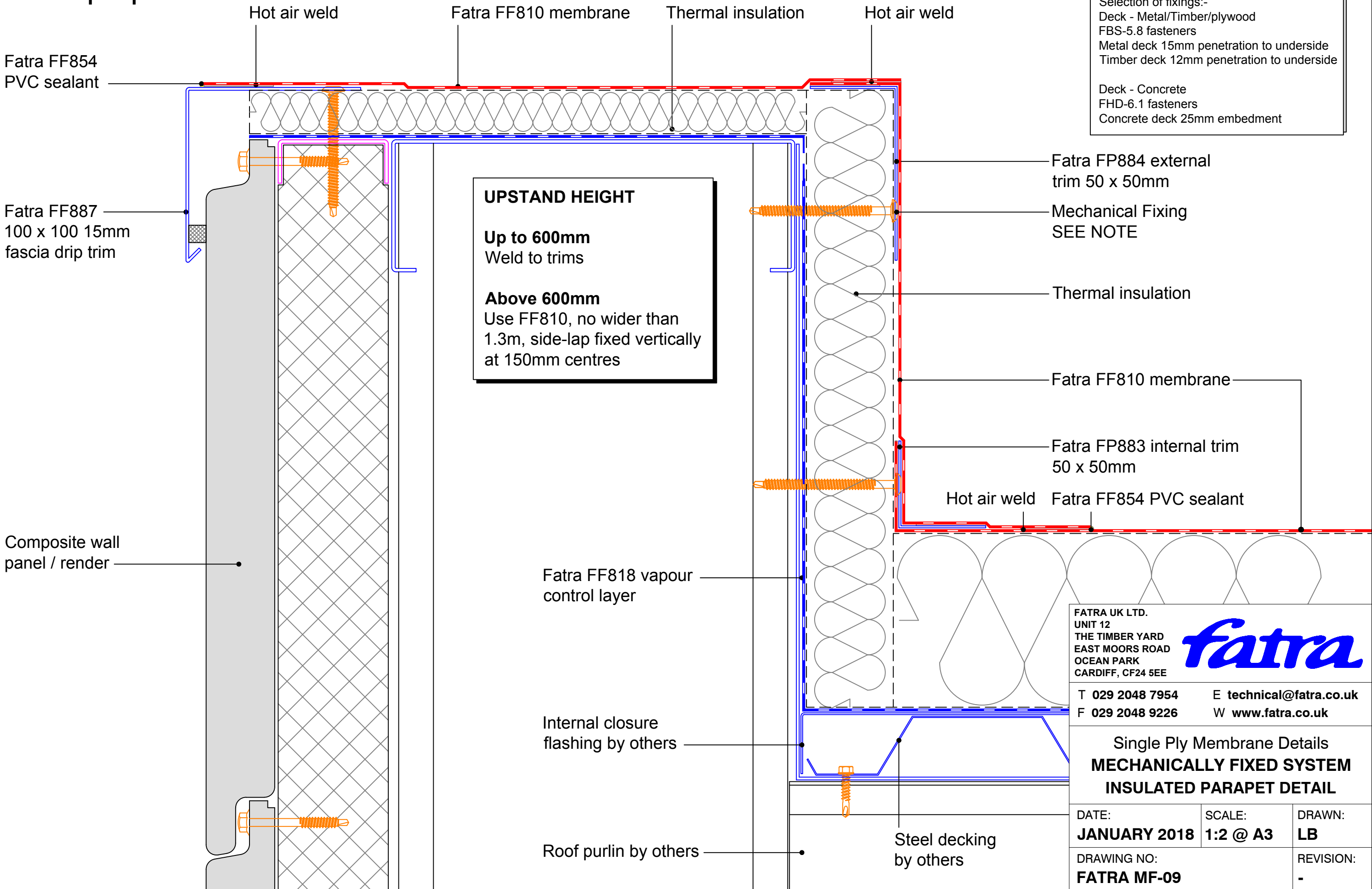

UPSTAND HEIGHT

Up to 600mm
Weld to trims

Above 600mm
Use FF810, no wider than 1.3m, side-lap fixed vertically at 150mm centres

FATRA UK LTD.
 UNIT 12
 THE TIMBER YARD
 EAST MOORS ROAD
 OCEAN PARK
 CARDIFF, CF24 5EE

fatra

T 029 2048 7954 E technical@fatra.co.uk
 F 029 2048 9226 W www.fatra.co.uk

Single Ply Membrane Details
MECHANICALLY FIXED SYSTEM
INSULATED PARAPET DETAIL

DATE: JANUARY 2018	SCALE: 1:2 @ A3	DRAWN: LB
DRAWING NO: FATRA MF-09		REVISION: -

Single Ply Membrane Details
Mechanically Fixed System
Un-Insulated parapet detail

MECHANICAL FIXINGS:-

Selection of fixings:-
 Deck - Metal/Timber/plywood
 FBS-5.8 fasteners
 Metal deck 15mm penetration to underside
 Timber deck 12mm penetration to underside

Deck - Concrete
 FHD-6.1 fasteners
 Concrete deck 25mm embedment

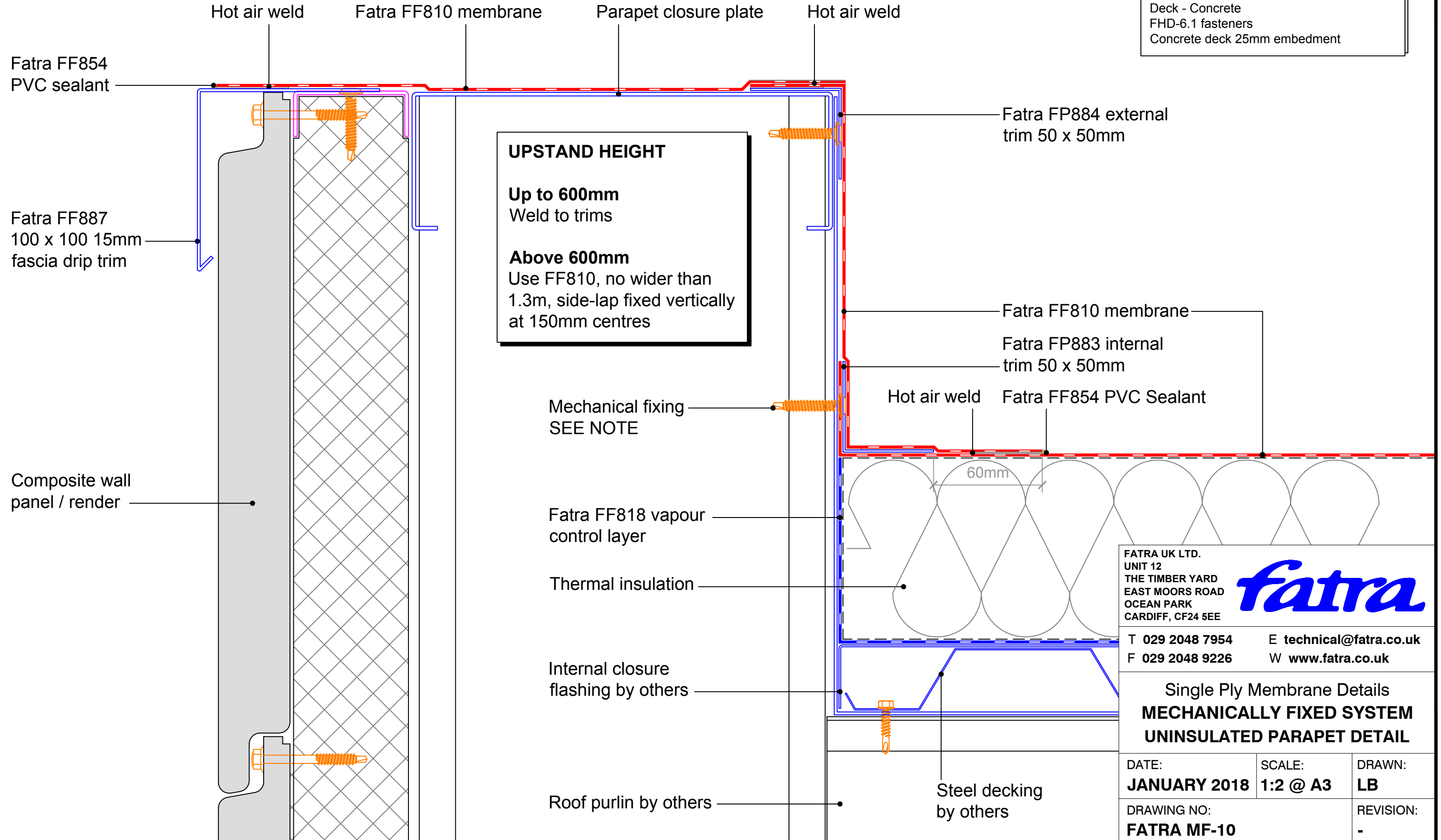

UPSTAND HEIGHT
Up to 600mm
 Weld to trims
Above 600mm
 Use FF810, no wider than 1.3m, side-lap fixed vertically at 150mm centres

FATRA UK LTD.
 UNIT 12
 THE TIMBER YARD
 EAST MOORS ROAD
 OCEAN PARK
 CARDIFF, CF24 5EE



T 029 2048 7954 E technical@fatra.co.uk
 F 029 2048 9226 W www.fatra.co.uk

Single Ply Membrane Details
MECHANICALLY FIXED SYSTEM
UNINSULATED PARAPET DETAIL

DATE: JANUARY 2018	SCALE: 1:2 @ A3	DRAWN: LB
DRAWING NO: FATRA MF-10		REVISION: -

Single Ply Membrane Details

Mechanically Fixed System

Parapet coping detail

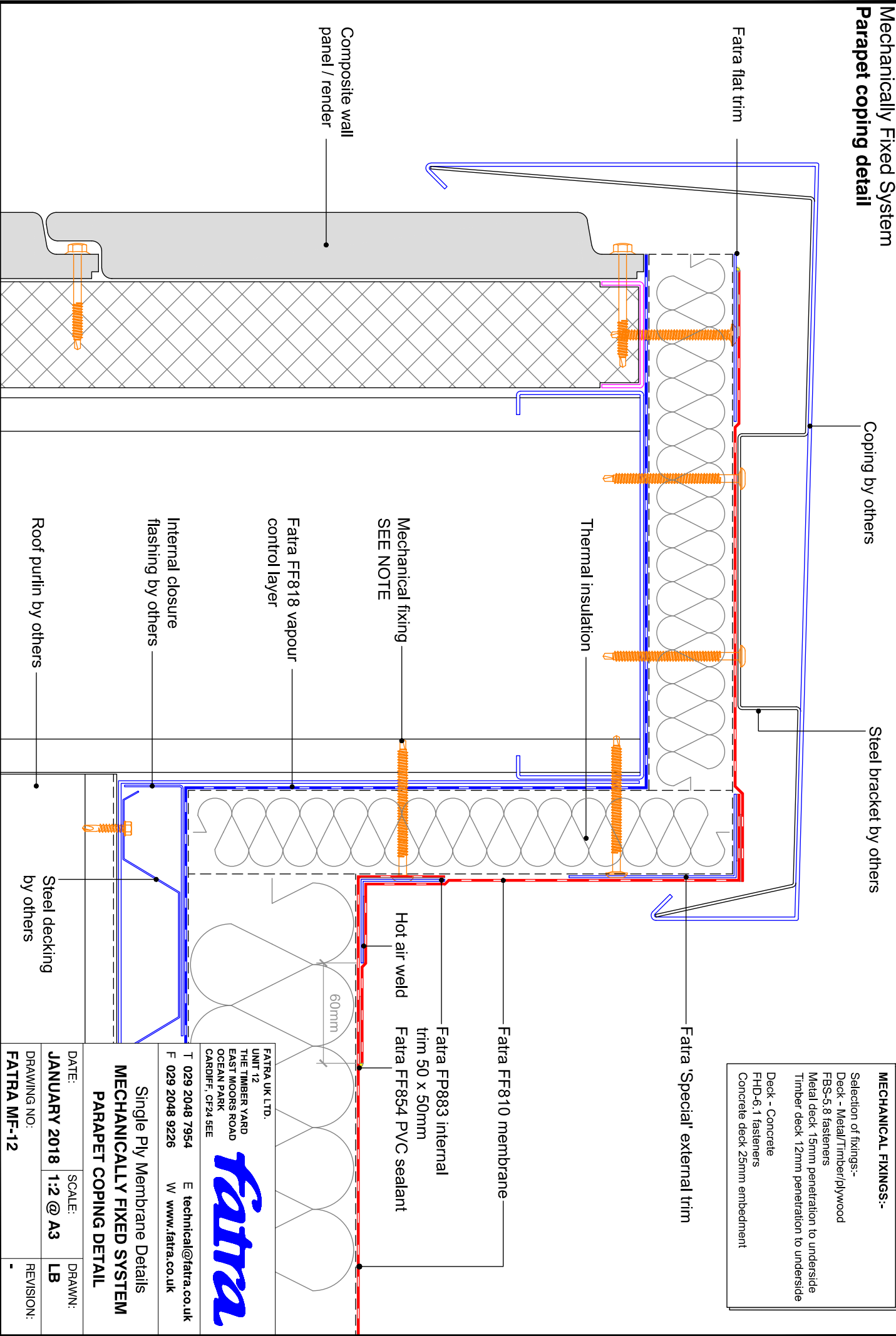

Coping by others

Steel bracket by others

MECHANICAL FIXINGS:-
 Selection of fixings:-
 Deck - Metal/Timber/plywood
 FBS-5.8 fasteners
 Metal deck 15mm penetration to underside
 Timber deck 12mm penetration to underside
 Deck - Concrete
 FHD-6, 1 fasteners
 Concrete deck 25mm embedment

Fatra 'Special' external trim

Fatra FF810 membrane

Fatra FP883 internal trim 50 x 50mm
 Fatra FF854 PVC sealant

60mm

Mechanical fixing
 SEE NOTE

Fatra FF818 vapour control layer

Internal closure flashing by others

Roof purlin by others

Steel decking by others

FATRA UK LTD.
 UNIT 12
 THE TIMBER YARD
 EAST MOORS ROAD
 OCEAN PARK
 CARDIFF, CF24 5EE

Fatra

T 029 2048 7954 E technical@fatra.co.uk
 F 029 2048 9226 W www.fatra.co.uk

Single Ply Membrane Details
MECHANICALLY FIXED SYSTEM
PARAPET COPING DETAIL

DATE:	JANUARY 2018	SCALE:	1:2 @ A3	DRAWN:	LB
DRAWING NO.:	FATRA MF-12	REVISION:	-		

Single Ply Membrane Details
Mechanically Fixed System
Plant plinth detail

MECHANICAL FIXINGS:-

Selection of fixings:-
 Deck - Metal/Timber/plywood
 FBS-5.8 fasteners
 Metal deck 15mm penetration to underside
 Timber deck 12mm penetration to underside

Deck - Concrete
 FHD-6.1 fasteners
 Concrete deck 25mm embedment

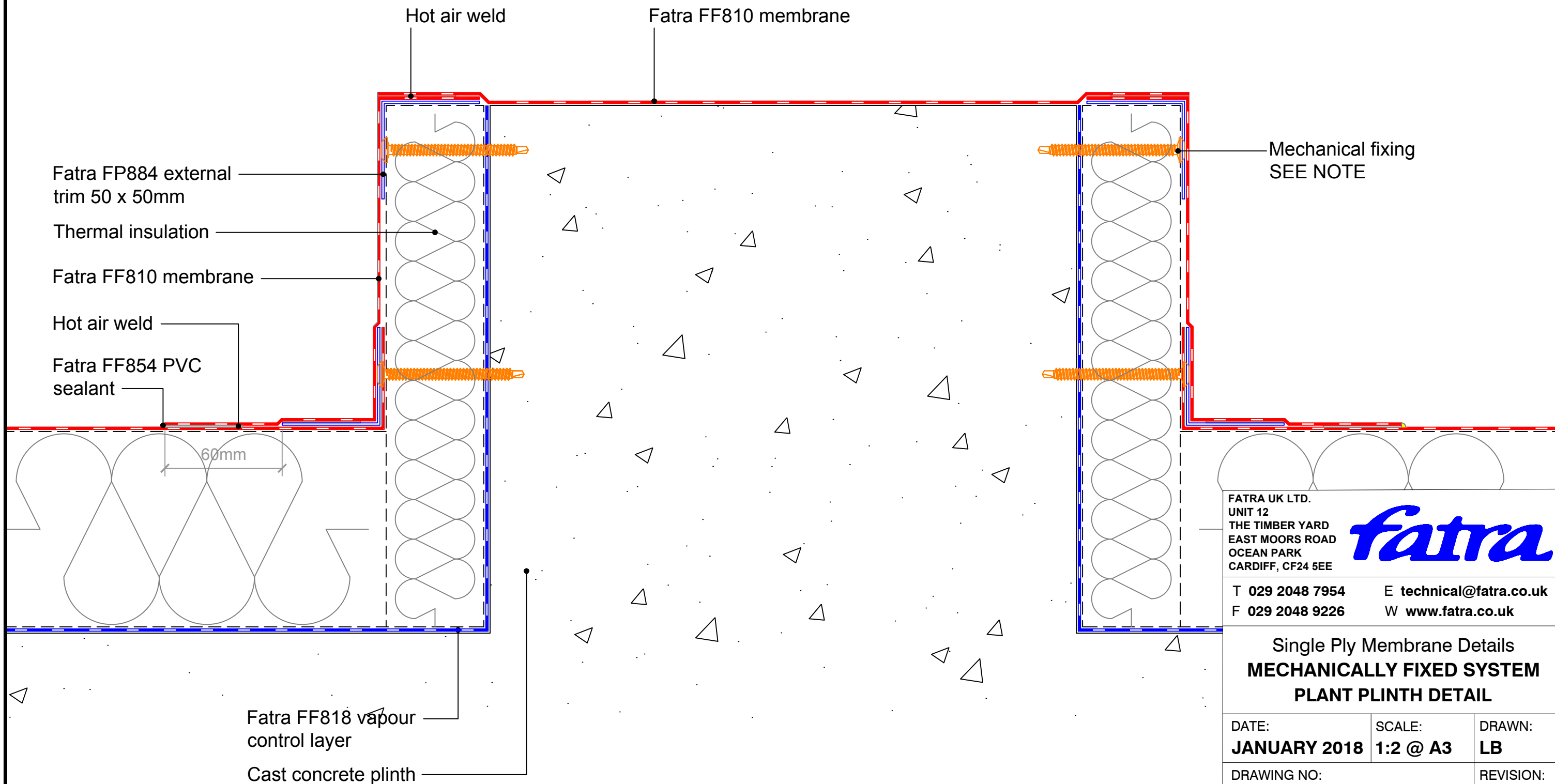

FATRA UK LTD.
 UNIT 12
 THE TIMBER YARD
 EAST MOORS ROAD
 OCEAN PARK
 CARDIFF, CF24 5EE



T 029 2048 7954 E technical@fatra.co.uk
 F 029 2048 9226 W www.fatra.co.uk

Single Ply Membrane Details
MECHANICALLY FIXED SYSTEM
PLANT PLINTH DETAIL

DATE: JANUARY 2018	SCALE: 1:2 @ A3	DRAWN: LB
DRAWING NO: FATRA MF-20		REVISION: -

Single Ply Membrane Details
Mechanically Fixed System
Step / change of height detail

UPSTAND HEIGHT

Up to 600mm
Weld to trims

Above 600mm
Use FF810, no wider than 1.3m, side-lap fixed vertically at 150mm centres

MECHANICAL FIXINGS:-

Selection of fixings:-
Deck - Metal/Timber/plywood
FBS-5.8 fasteners
Metal deck 15mm penetration to underside
Timber deck 12mm penetration to underside

Deck - Concrete
FHD-6.1 fasteners
Concrete deck 25mm embedment

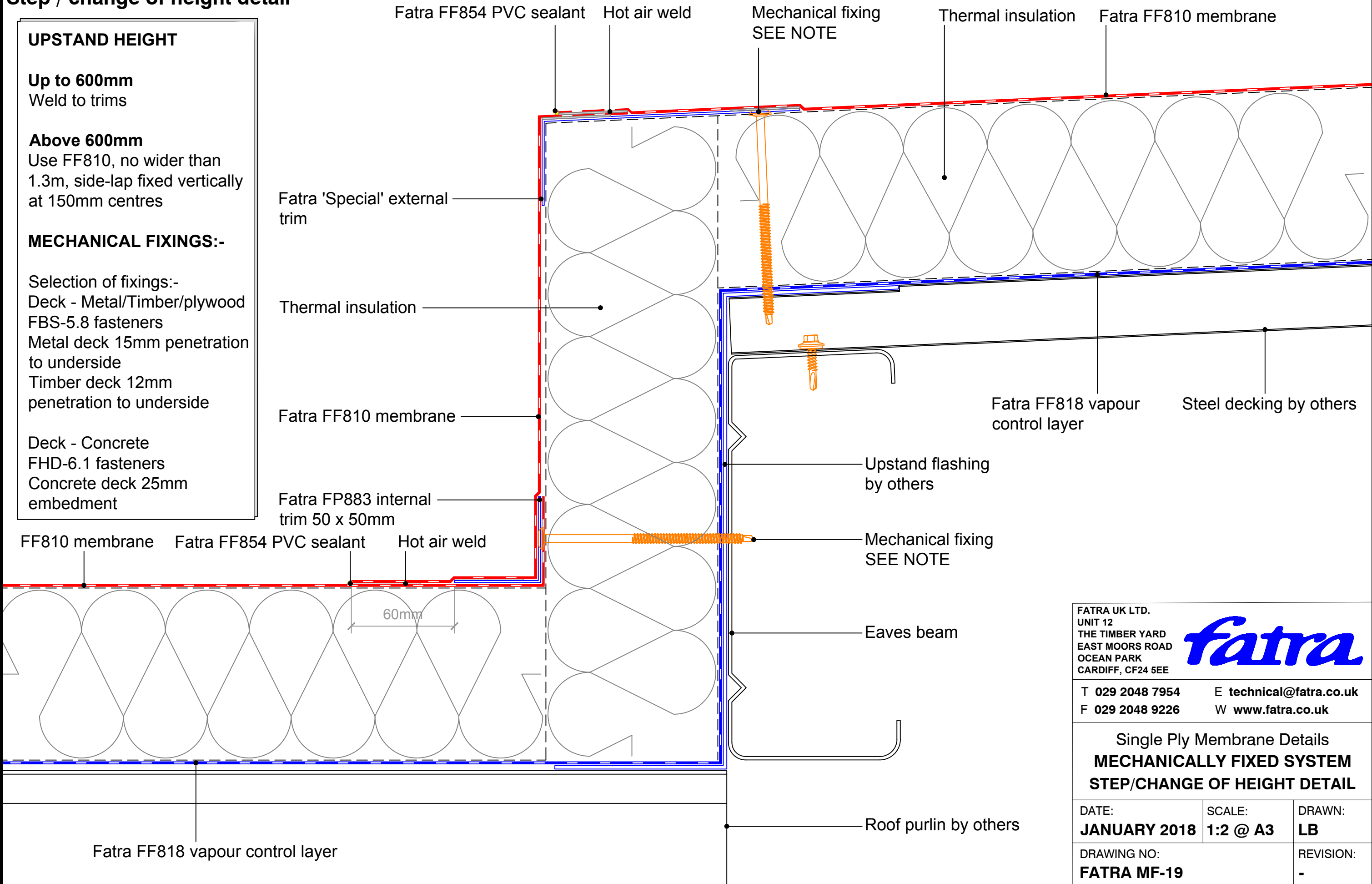

FATRA UK LTD.
UNIT 12
THE TIMBER YARD
EAST MOORS ROAD
OCEAN PARK
CARDIFF, CF24 5EE

fatra

T 029 2048 7954 E technical@fatra.co.uk
F 029 2048 9226 W www.fatra.co.uk

Single Ply Membrane Details
MECHANICALLY FIXED SYSTEM
STEP/CHANGE OF HEIGHT DETAIL

DATE: JANUARY 2018	SCALE: 1:2 @ A3	DRAWN: LB
DRAWING NO: FATRA MF-19		REVISION: -

Single Ply Membrane Details
Mechanically Fixed System
Sedum roof detail

MECHANICAL FIXINGS:-

Selection of fixings:-
 Deck - Metal/Timber/plywood
 FBS-5.8 fasteners
 Metal deck 15mm penetration to underside
 Timber deck 12mm penetration to underside

Deck - Concrete
 FHD-6.1 fasteners
 Concrete deck 25mm embedment

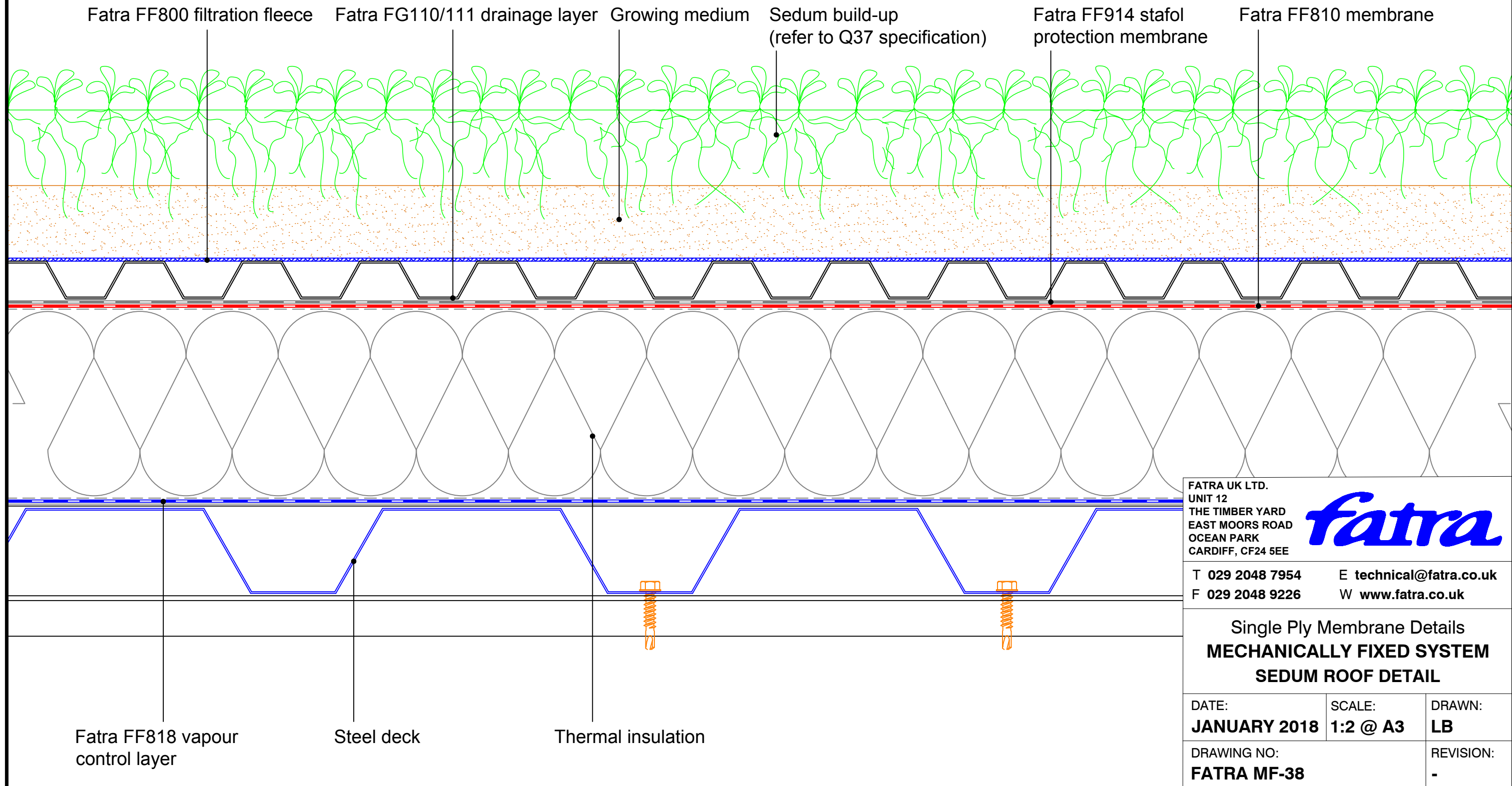

FATRA UK LTD.
 UNIT 12
 THE TIMBER YARD
 EAST MOORS ROAD
 OCEAN PARK
 CARDIFF, CF24 5EE



T 029 2048 7954 E technical@fatratra.co.uk
 F 029 2048 9226 W www.fatratra.co.uk

Single Ply Membrane Details
MECHANICALLY FIXED SYSTEM
SEDUM ROOF DETAIL

DATE: JANUARY 2018	SCALE: 1:2 @ A3	DRAWN: LB
DRAWING NO: FATRA MF-38		REVISION: -

Single Ply Membrane Details

Mechanically Fixed System

Sedum roof with paving slabs detail

MECHANICAL FIXINGS:-

Selection of fixings:-

Deck - Metal/Timber/plywood

FBS-5.8 fasteners

Metal deck 15mm penetration to underside

Timber deck 12mm penetration to underside

Deck - Concrete

FHD-6.1 fasteners

Concrete deck 25mm embedment

Fatra FF914 stafol
protection membrane

Fatra FF800 filtration fleece

Fatra FG110/111
drainage layer

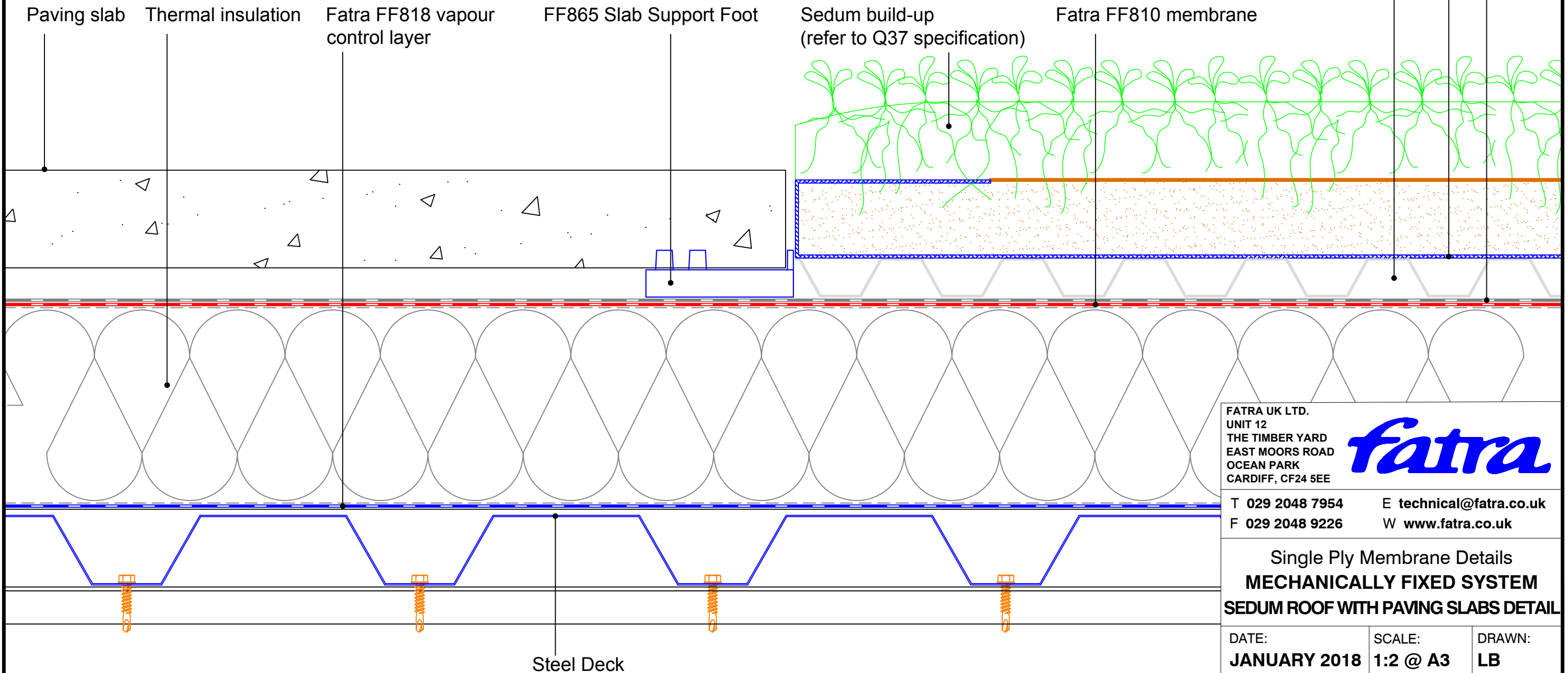

FATRA UK LTD.
UNIT 12
THE TIMBER YARD
EAST MOORS ROAD
OCEAN PARK
CARDIFF, CF24 5EE

fatra

T 029 2048 7954

E technical@fatra.co.uk

F 029 2048 9226

W www.fatra.co.uk

Single Ply Membrane Details
MECHANICALLY FIXED SYSTEM
SEDUM ROOF WITH PAVING SLABS DETAIL

DATE:
JANUARY 2018

SCALE:
1:2 @ A3

DRAWN:
LB

DRAWING NO:
FATRA MF-40

REVISION:
-

Single Ply Membrane Details
Mechanically Fixed System
Sedum roof with outlet detail 1

MECHANICAL FIXINGS:-

Selection of fixings:-
 Deck - Metal/Timber/plywood
 FBS-5.8 fasteners
 Metal deck 15mm penetration to underside
 Timber deck 12mm penetration to underside

Deck - Concrete
 FHD-6.1 fasteners
 Concrete deck 25mm embedment

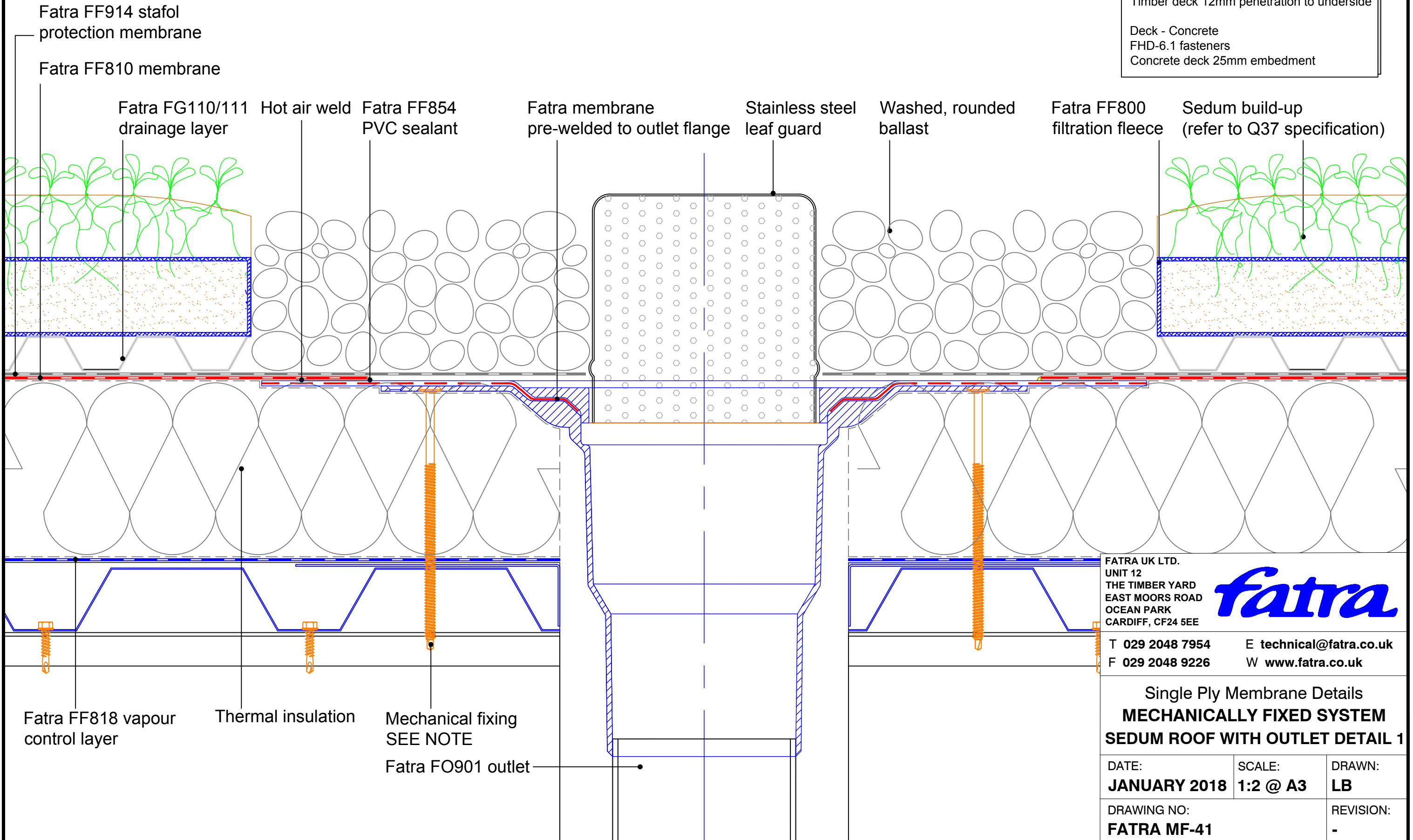

FATRA UK LTD.
 UNIT 12
 THE TIMBER YARD
 EAST MOORS ROAD
 OCEAN PARK
 CARDIFF, CF24 5EE



T 029 2048 7954 E technical@fatra.co.uk
 F 029 2048 9226 W www.fatra.co.uk

Single Ply Membrane Details
MECHANICALLY FIXED SYSTEM
SEDUM ROOF WITH OUTLET DETAIL 1

DATE: JANUARY 2018	SCALE: 1:2 @ A3	DRAWN: LB
DRAWING NO: FATRA MF-41		REVISION: -

Single Ply Membrane Details
Mechanically Fixed System
Sedum roof with outlet detail 2

MECHANICAL FIXINGS:-

Selection of fixings:-
 Deck - Metal/Timber/plywood
 FBS-5.8 fasteners
 Metal deck 15mm penetration to underside
 Timber deck 12mm penetration to underside

Deck - Concrete
 FHD-6.1 fasteners
 Concrete deck 25mm embedment

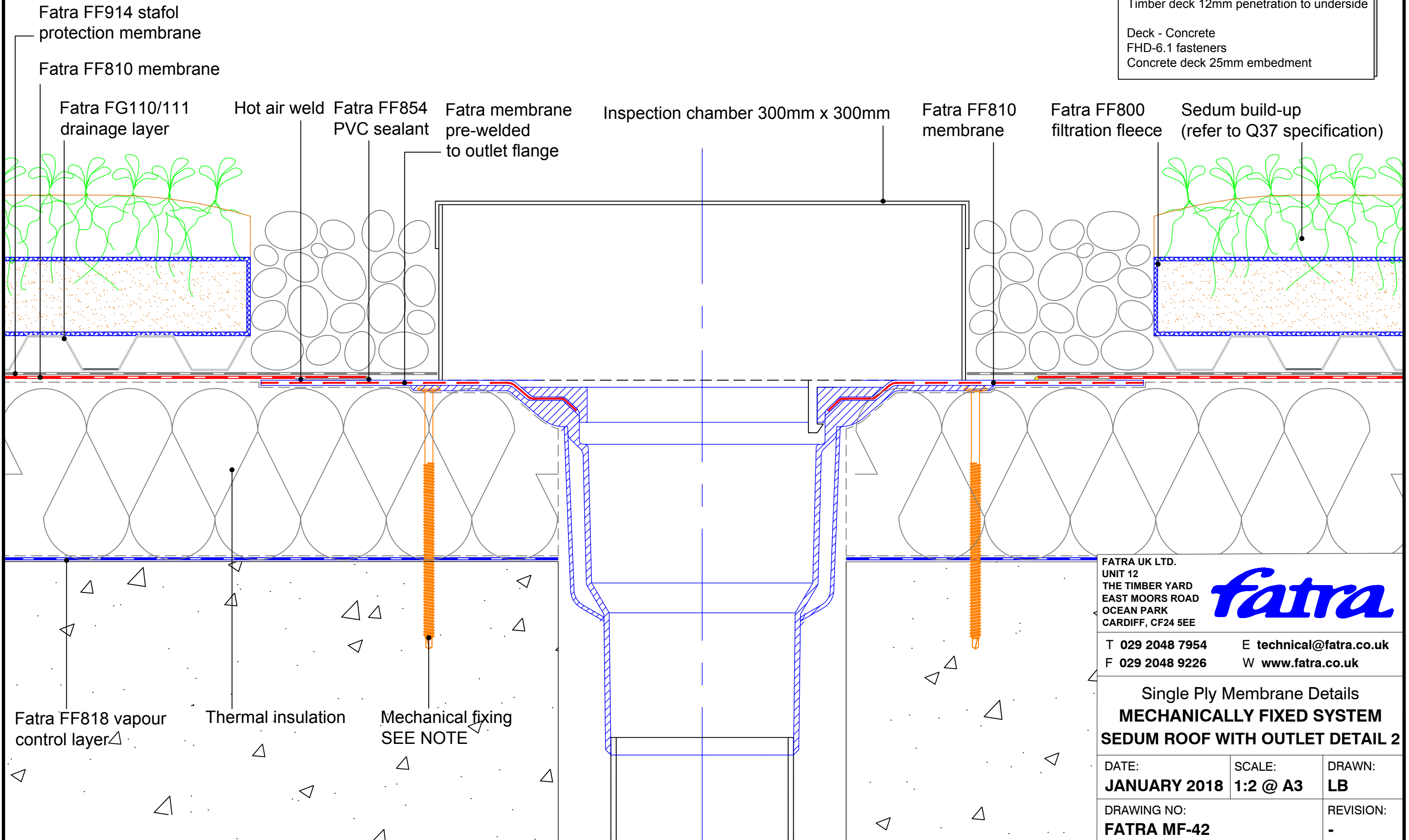

FATRA UK LTD.
 UNIT 12
 THE TIMBER YARD
 EAST MOORS ROAD
 OCEAN PARK
 CARDIFF, CF24 5EE



T 029 2048 7954 E technical@fatra.co.uk
 F 029 2048 9226 W www.fatra.co.uk

Single Ply Membrane Details
MECHANICALLY FIXED SYSTEM
SEDUM ROOF WITH OUTLET DETAIL 2

DATE: JANUARY 2018	SCALE: 1:2 @ A3	DRAWN: LB
DRAWING NO: FATRA MF-42		REVISION: -

Single Ply Membrane Details
Mechanically Fixed System
Sedum roof with parapet detail

MECHANICAL FIXINGS:-

Selection of fixings:-
 Deck - Metal/Timber/plywood
 FBS-5.8 fasteners
 Metal deck 15mm penetration to underside
 Timber deck 12mm penetration to underside

Deck - Concrete
 FHD-6.1 fasteners
 Concrete deck 25mm embedment

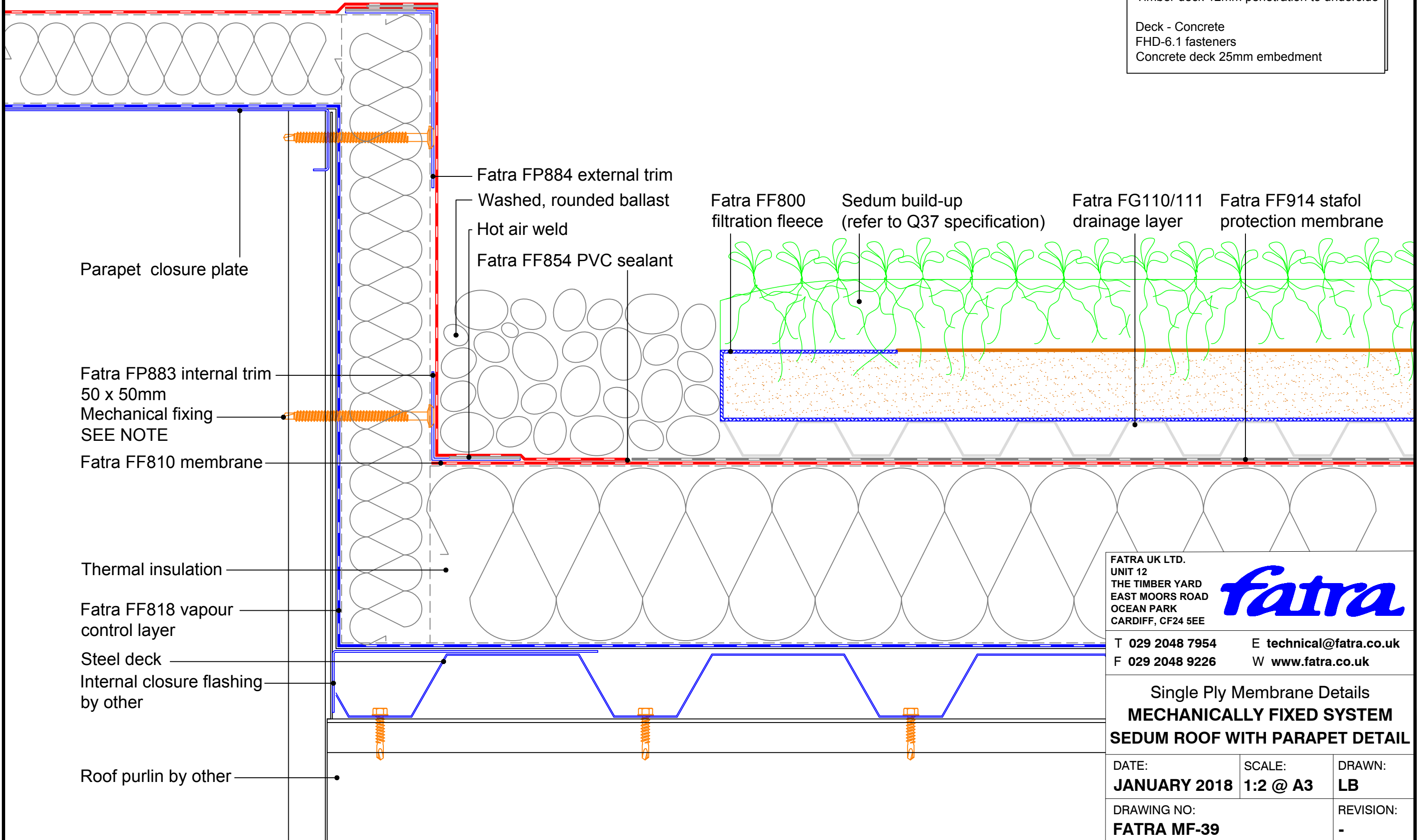

FATRA UK LTD.
 UNIT 12
 THE TIMBER YARD
 EAST MOORS ROAD
 OCEAN PARK
 CARDIFF, CF24 5EE



T 029 2048 7954
 F 029 2048 9226

E technical@fatra.co.uk
 W www.fatra.co.uk

Single Ply Membrane Details
MECHANICALLY FIXED SYSTEM
SEDUM ROOF WITH PARAPET DETAIL

DATE:
JANUARY 2018

SCALE:
1:2 @ A3

DRAWN:
LB

DRAWING NO:
FATRA MF-39

REVISION:
 -

Single Ply Membrane Details
Mechanically Fixed System
Section through side lap fixed

MECHANICAL FIXINGS:-

Selection of fixings:-
 Deck - Metal/Timber/plywood
 FBS-5.8 fasteners
 Metal deck 15mm penetration to underside
 Timber deck 12mm penetration to underside

Deck - Concrete
 FHD-6.1 fasteners
 Concrete deck 25mm embedment

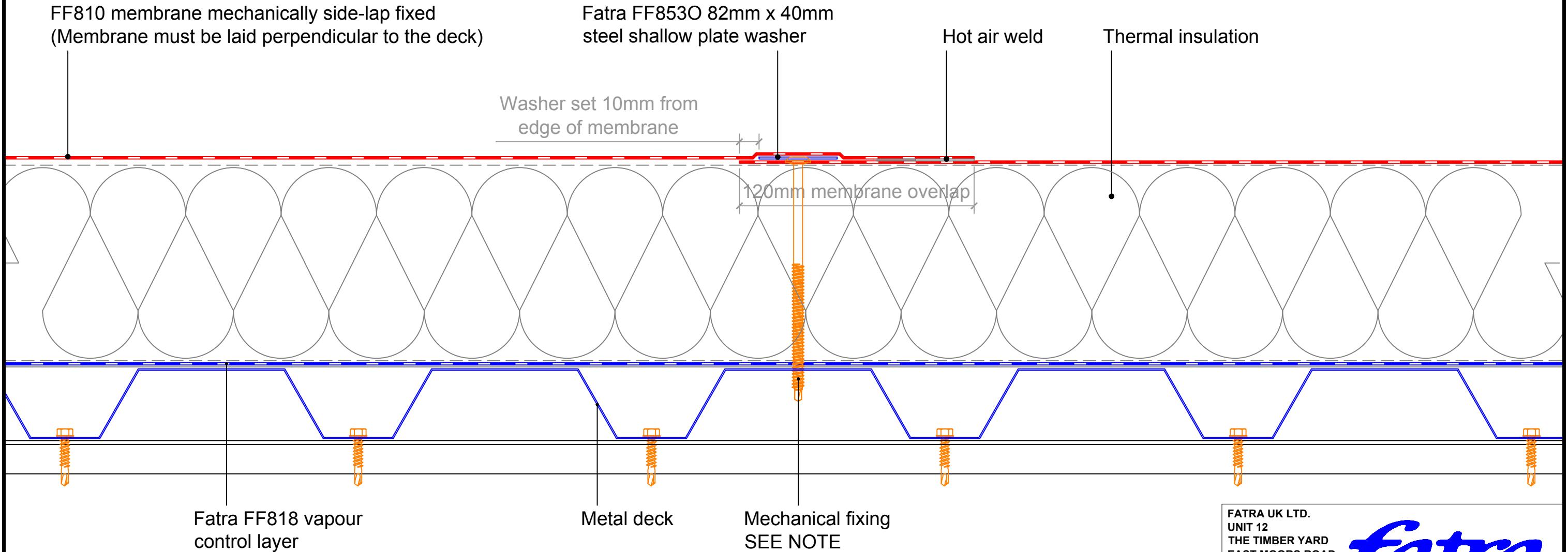

CONSTRUCTION NOTE:-

When side-lap fixing the membrane field area, a row of FF852 fixing discs should also be installed 200mm from the roof perimeter at a maximum spacing of 500mm

FATRA UK LTD.
 UNIT 12
 THE TIMBER YARD
 EAST MOORS ROAD
 OCEAN PARK
 CARDIFF, CF24 5EE



T 029 2048 7954 E technical@fatra.co.uk
 F 029 2048 9226 W www.fatra.co.uk

Single Ply Membrane Details
MECHANICALLY FIXED SYSTEM
SECTION THROUGH SIDE LAP FIXED

DATE: JANUARY 2018	SCALE: 1:2 @ A3	DRAWN: LB
DRAWING NO: FATRA MF-08		REVISION: -

Single Ply Membrane Details

Mechanically Fixed System

Fatralight rooflight detail 1

(150mm high kerb)

MECHANICAL FIXINGS:-

- Selection of fixings:-
- Deck - Metal/Timber/plywood
FBS-5.8 fasteners
- Metal deck 15mm penetration to underside
- Timber deck 12mm penetration to underside
- Deck - Concrete
FHD-6.1 fasteners
- Concrete deck 25mm embedment

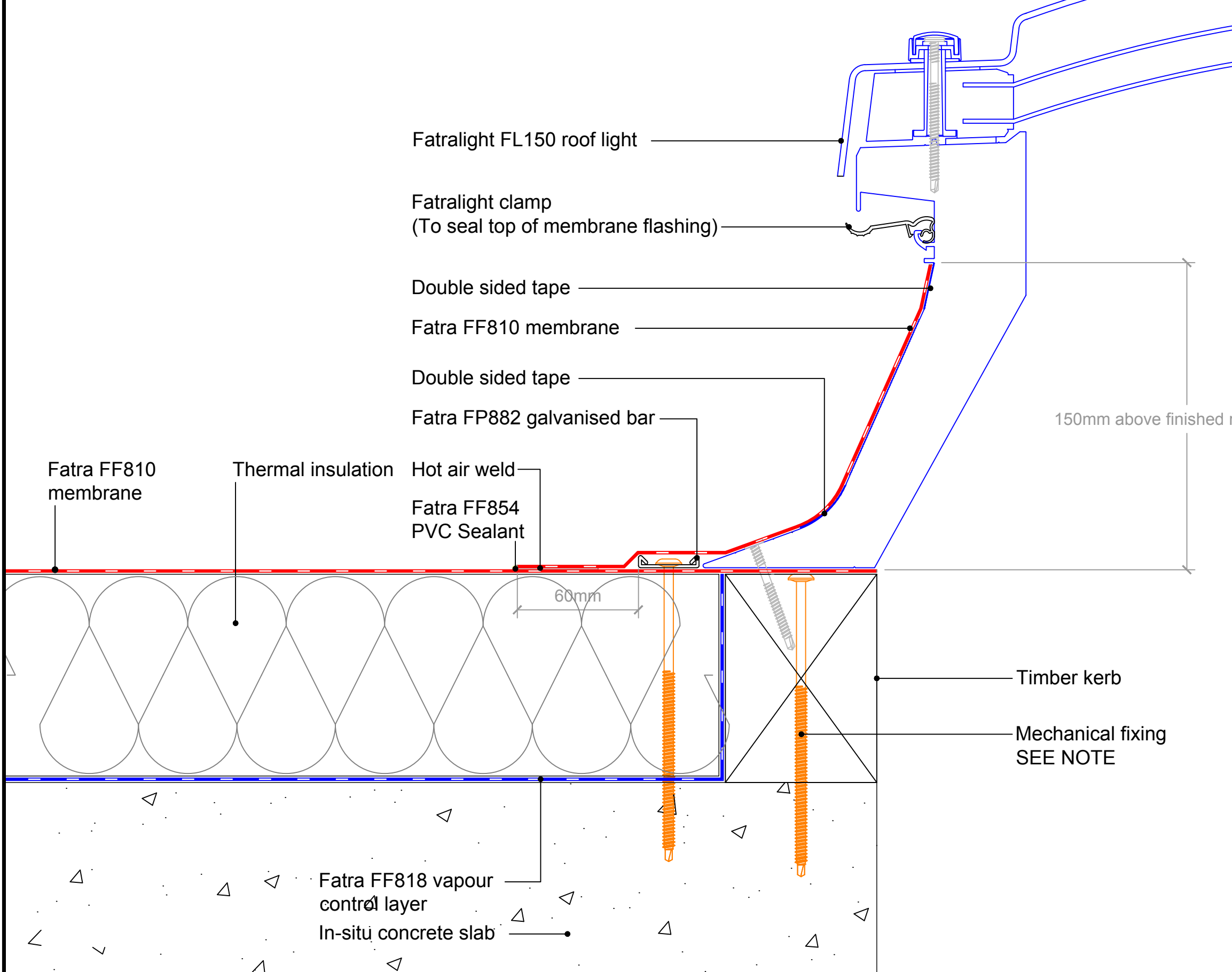

FATRA UK LTD. UNIT 12 THE TIMBER YARD EAST MOORS ROAD OCEAN PARK CARDIFF, CF24 5EE		
T 029 2048 7954 F 029 2048 9226	E technical@fatra.co.uk W www.fatra.co.uk	
Single Ply Membrane Details MECHANICALLY FIXED SYSTEM FATRALIGHT ROOFLIGHT DETAIL 1		
DATE: JANUARY 2018	SCALE: 1:2 @ A3	DRAWN: LB
DRAWING NO: FATRA MF-47		REVISION: -

Single Ply Membrane Details
Mechanically Fixed System
Fatralight rooflight detail 2
(300mm high kerb)

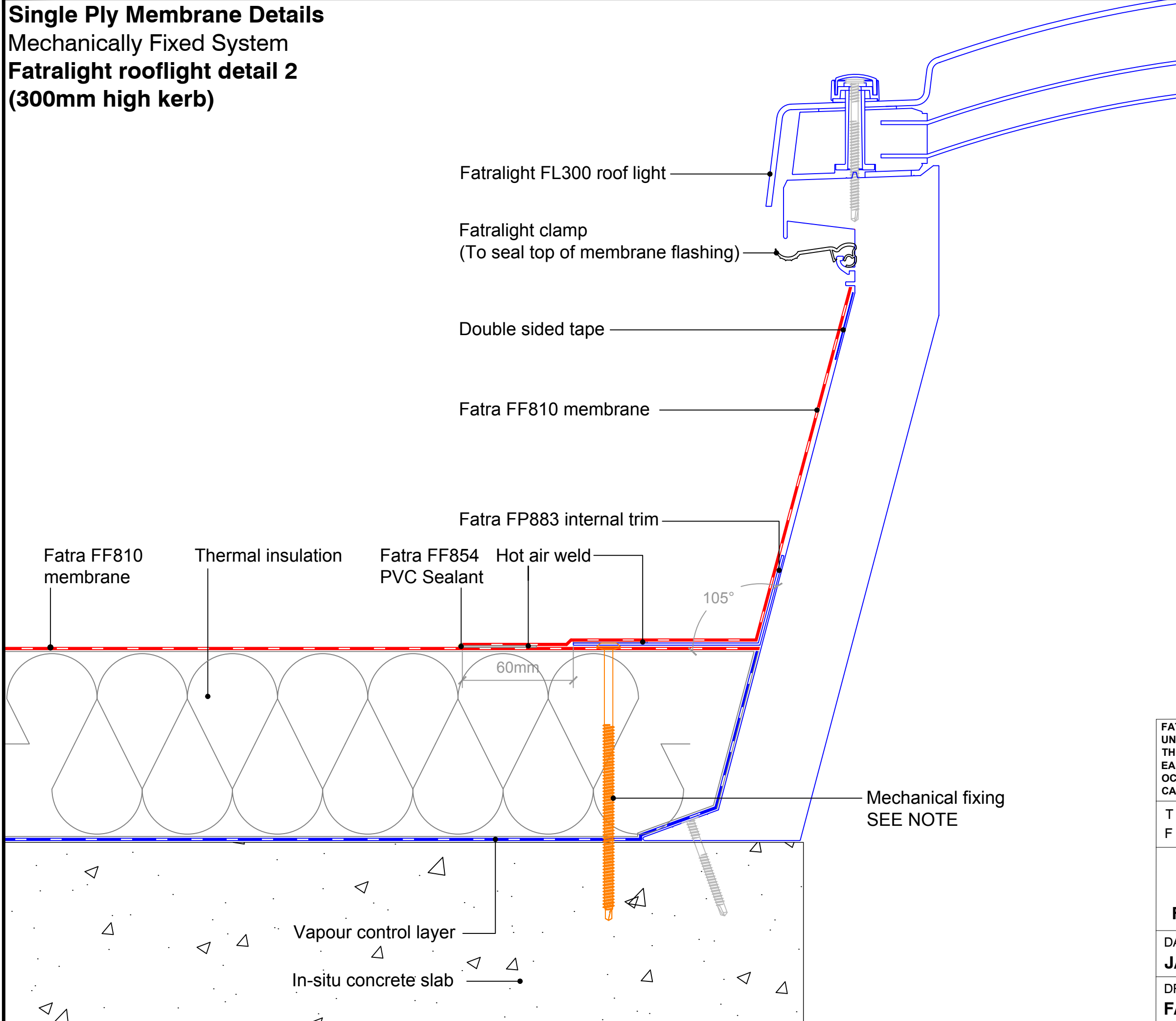

MECHANICAL FIXINGS:-

Selection of fixings:-
 Deck - Metal/Timber/plywood
 FBS-5.8 fasteners
 Metal deck 15mm penetration to underside
 Timber deck 12mm penetration to underside

Deck - Concrete
 FHD-6.1 fasteners
 Concrete deck 25mm embedment

FATRA UK LTD.
 UNIT 12
 THE TIMBER YARD
 EAST MOORS ROAD
 OCEAN PARK
 CARDIFF, CF24 5EE



T 029 2048 7954 E technical@fatra.co.uk
 F 029 2048 9226 W www.fatra.co.uk

Single Ply Membrane Details
MECHANICALLY FIXED SYSTEM
FATRALIGHT ROOFLIGHT DETAIL 2

DATE: JANUARY 2018	SCALE: 1:2 @ A3	DRAWN: LB
------------------------------	---------------------------	---------------------

DRAWING NO: FATRA MF-48	REVISION: -
-----------------------------------	----------------

Single Ply Membrane Details
Mechanically Fixed System
Smoke Vent Detail

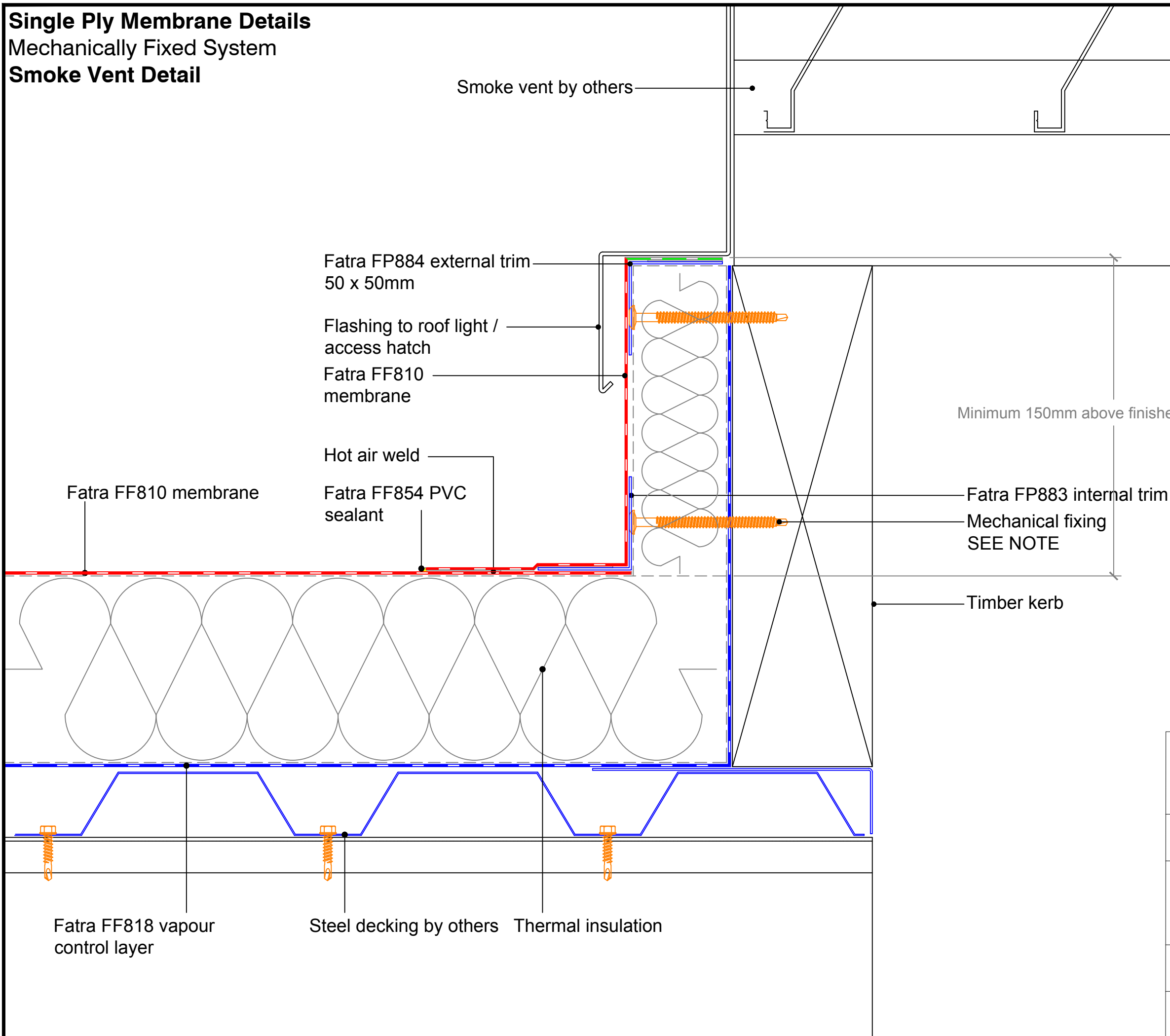

MECHANICAL FIXINGS:-

Selection of fixings:-
 Deck - Metal/Timber/plywood
 FBS-5.8 fasteners
 Metal deck 15mm penetration to underside
 Timber deck 12mm penetration to underside

Deck - Concrete
 FHD-6.1 fasteners
 Concrete deck 25mm embedment

FATRA UK LTD.
 UNIT 12
 THE TIMBER YARD
 EAST MOORS ROAD
 OCEAN PARK
 CARDIFF, CF24 5EE



T 029 2048 7954 E technical@fatra.co.uk
 F 029 2048 9226 W www.fatra.co.uk

Single Ply Membrane Details
MECHANICALLY FIXED SYSTEM
SMOKE VENT DETAIL

DATE: JANUARY 2018	SCALE: 1:2 @ A3	DRAWN: LB
------------------------------	---------------------------	---------------------

DRAWING NO: FATRA MF-49	REVISION: -
-----------------------------------	-----------------------

Single Ply Membrane Details
Mechanically Fixed System
Column penetration detail

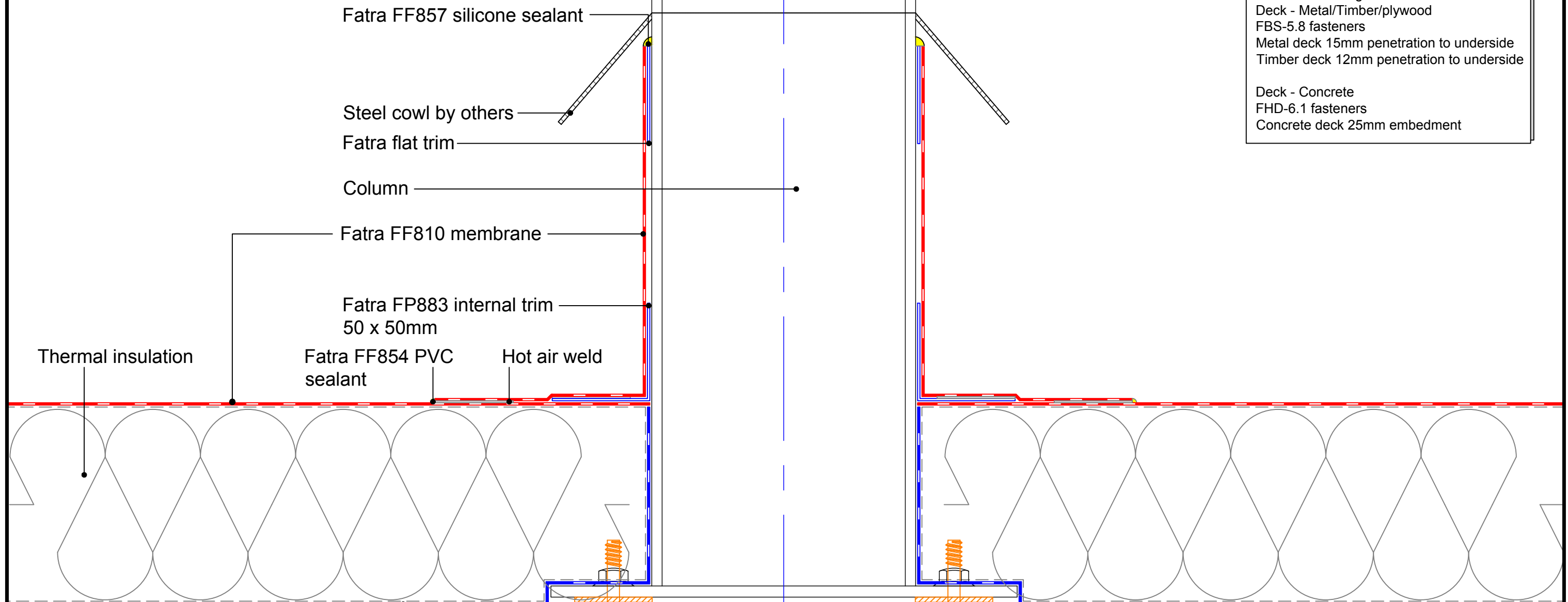

MECHANICAL FIXINGS:-

Selection of fixings:-
 Deck - Metal/Timber/plywood
 FBS-5.8 fasteners
 Metal deck 15mm penetration to underside
 Timber deck 12mm penetration to underside

Deck - Concrete
 FHD-6.1 fasteners
 Concrete deck 25mm embedment

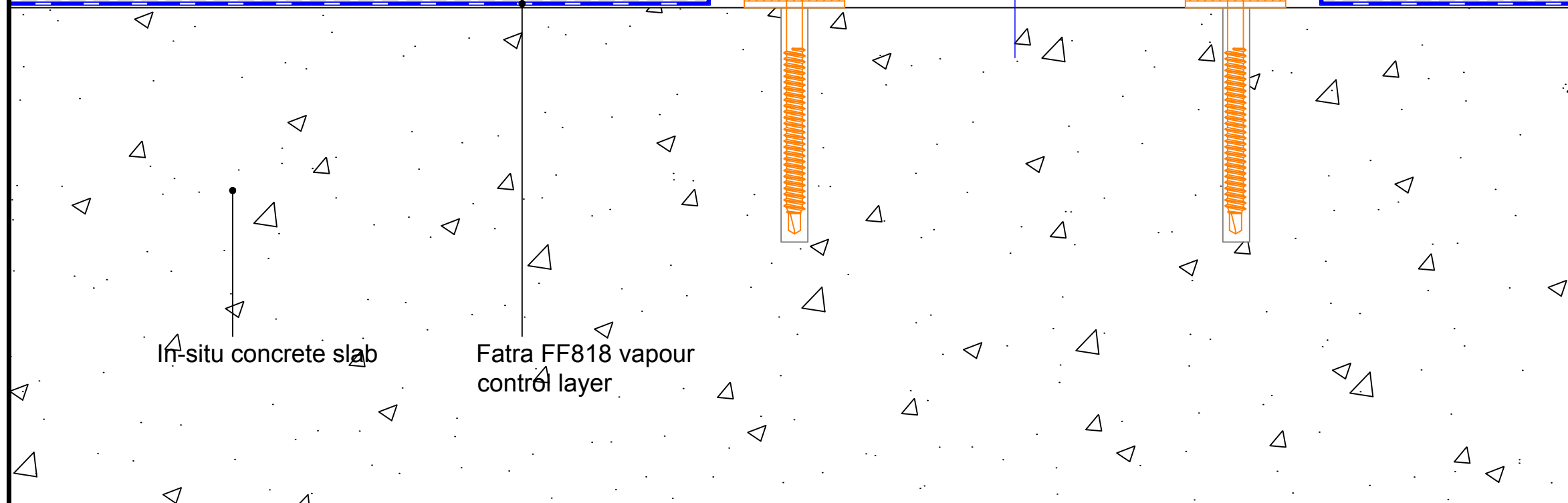

FATRA UK LTD. UNIT 12 THE TIMBER YARD EAST MOORS ROAD OCEAN PARK CARDIFF, CF24 5EE		
T 029 2048 7954 F 029 2048 9226	E technical@fatra.co.uk W www.fatra.co.uk	
Single Ply Membrane Details MECHANICALLY FIXED SYSTEM COLUMN PENETRATION DETAIL		
DATE: JANUARY 2018	SCALE: 1:2 @ A3	DRAWN: LB
DRAWING NO: FATRA MF-32		REVISION: -

Single Ply Membrane Details
Mechanically Fixed System
Through wall outlet detail

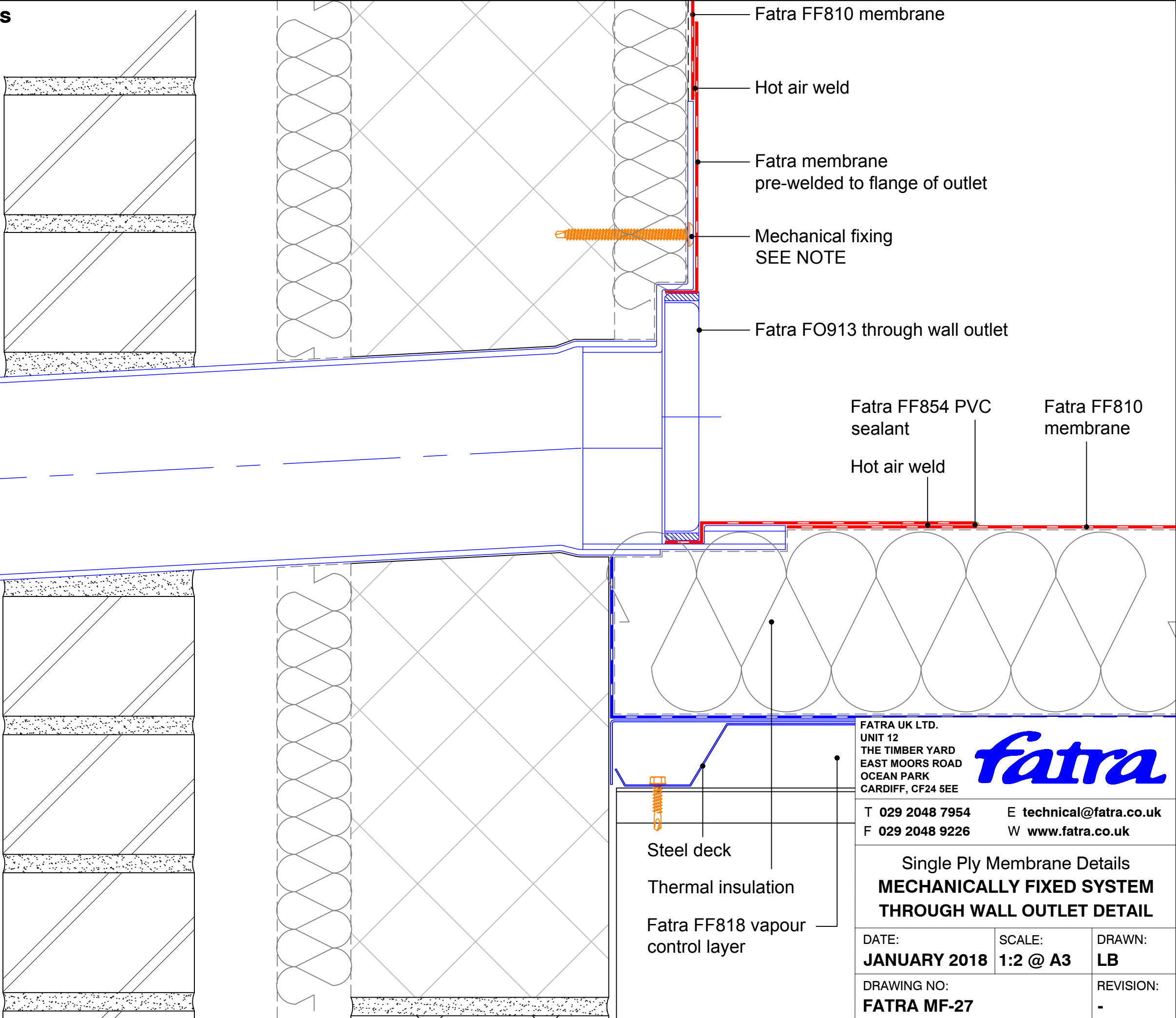

MECHANICAL FIXINGS:-

Selection of fixings:-
 Deck - Metal/Timber/plywood
 FBS-5.8 fasteners
 Metal deck 15mm penetration to underside
 Timber deck 12mm penetration to underside

Deck - Concrete
 FHD-6.1 fasteners
 Concrete deck 25mm embedment

CONSTRUCTION NOTE:-

Horizontal outlets require the deck/insulation to be recessed for a flush finish

FATRA UK LTD.
 UNIT 12
 THE TIMBER YARD
 EAST MOORS ROAD
 OCEAN PARK
 CARDIFF, CF24 5EE

fatra

T 029 2048 7954 E technical@fatra.co.uk
 F 029 2048 9226 W www.fatra.co.uk

Single Ply Membrane Details
MECHANICALLY FIXED SYSTEM
THROUGH WALL OUTLET DETAIL

DATE: JANUARY 2018	SCALE: 1:2 @ A3	DRAWN: LB
DRAWING NO: FATRA MF-27		REVISION: -

Single Ply Membrane Details
Mechanically Fixed System
Overflow outlet detail

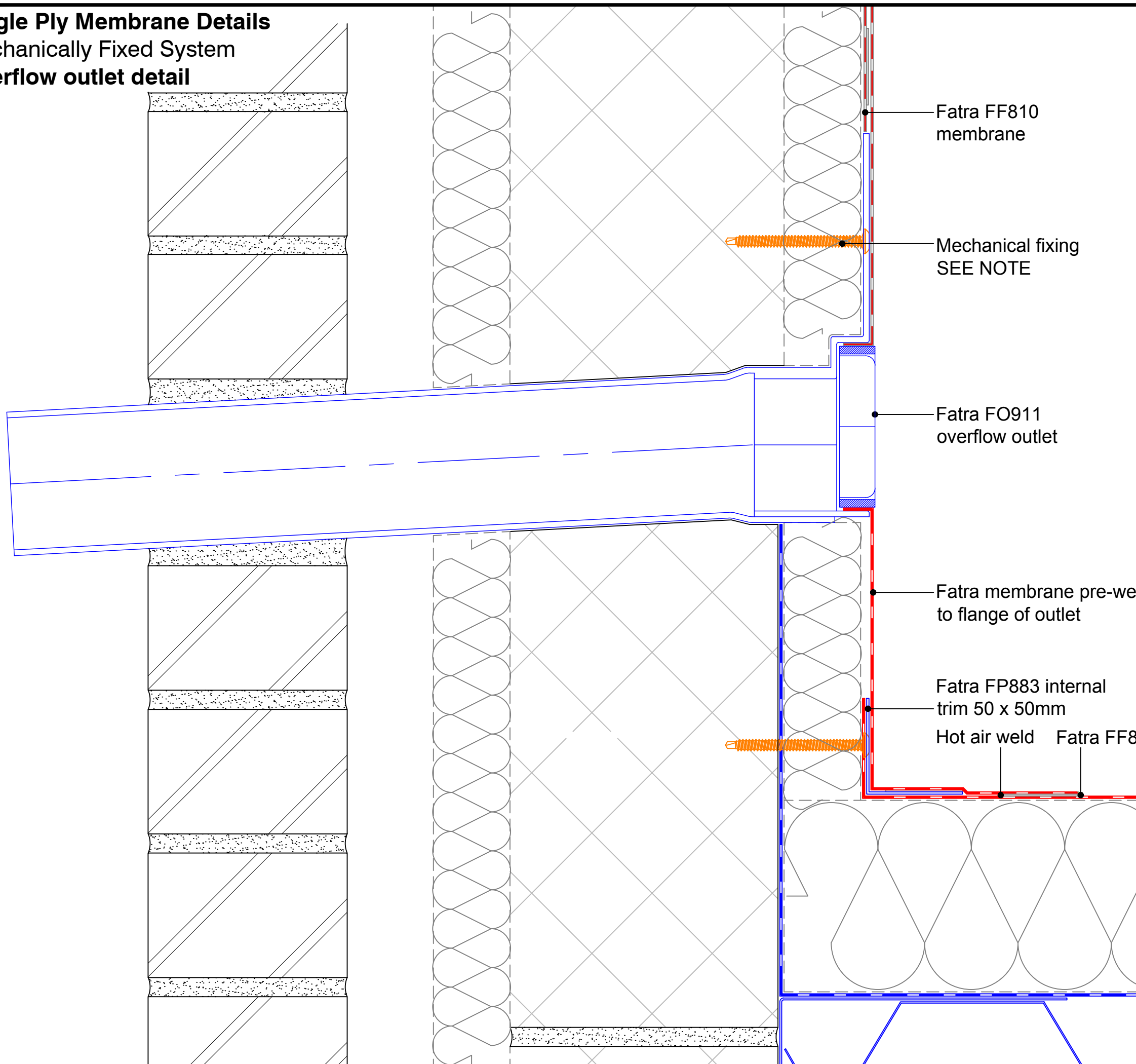

Fatra FF810 membrane

Mechanical fixing
SEE NOTE

Fatra FO911 overflow outlet

Fatra membrane pre-welded to flange of outlet

Fatra FP883 internal trim 50 x 50mm

Hot air weld Fatra FF854 PVC sealant

MECHANICAL FIXINGS:-

Selection of fixings:-
 Deck - Metal/Timber/plywood
 FBS-5.8 fasteners
 Metal deck 15mm penetration to underside
 Timber deck 12mm penetration to underside

Deck - Concrete
 FHD-6.1 fasteners
 Concrete deck 25mm embedment

FATRA UK LTD.
 UNIT 12
 THE TIMBER YARD
 EAST MOORS ROAD
 OCEAN PARK
 CARDIFF, CF24 5EE

fatra

T 029 2048 7954 E technical@fatra.co.uk
 F 029 2048 9226 W www.fatra.co.uk

Single Ply Membrane Details
MECHANICALLY FIXED SYSTEM
OVERFLOW OUTLET DETAIL

DATE: JANUARY 2018	SCALE: 1:2 @ A3	DRAWN: LB
DRAWING NO: FATRA MF-28		REVISION: -

Single Ply Membrane Details
 Mechanically Fixed System
 Roof section with timber decking

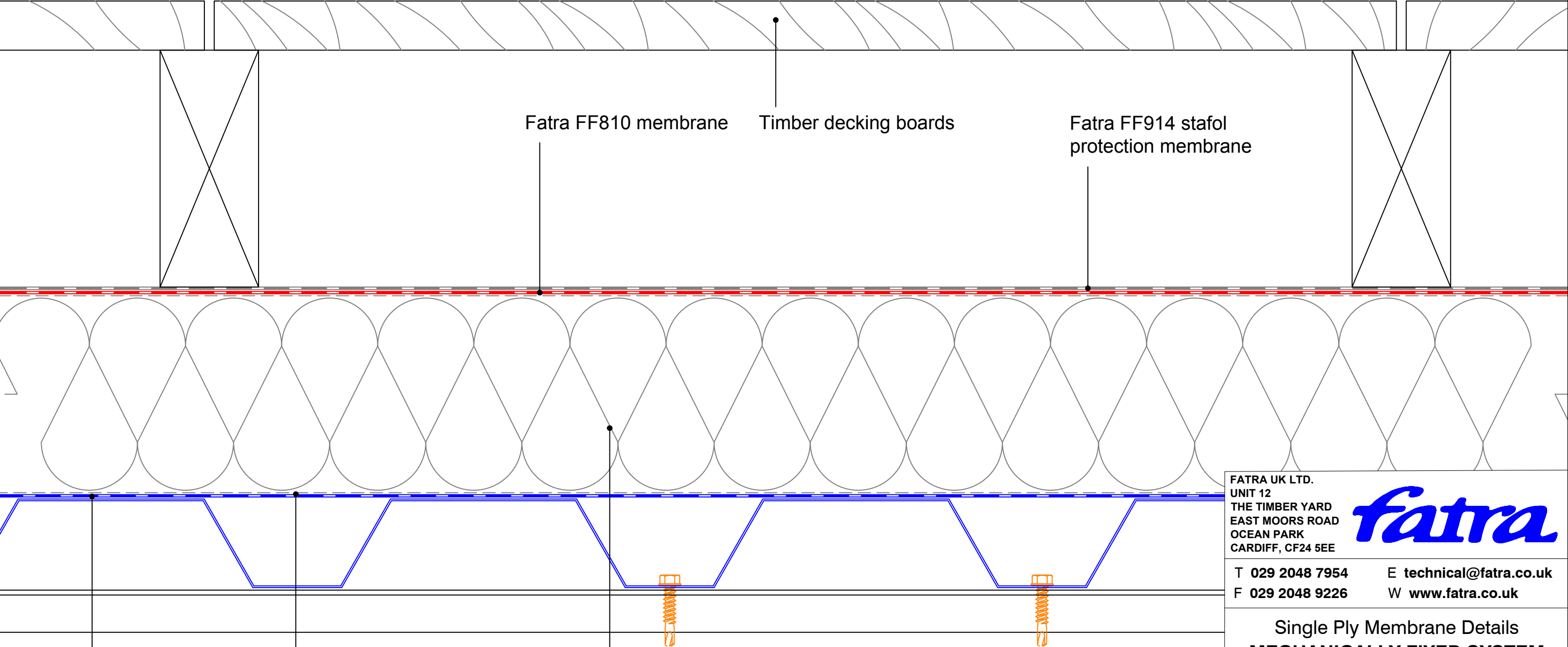

Fatra FF810 membrane

Timber decking boards

Fatra FF914 stafol protection membrane

Fatra FF818 vapour barrier

Fatra FF867 insulation adhesive

Thermal Insulation

FATRA UK LTD.
 UNIT 12
 THE TIMBER YARD
 EAST MOORS ROAD
 OCEAN PARK
 CARDIFF, CF24 5EE



T 029 2048 7954
 F 029 2048 9226

E technical@fatra.co.uk
 W www.fatra.co.uk

Single Ply Membrane Details
MECHANICALLY FIXED SYSTEM
ROOF SECTION WITH TIMBER DECKING

DATE:
JANUARY 2018

SCALE:
1:2 @ A3

DRAWN:
LB

DRAWING NO:
FATRA MF-44

REVISION:
 -

Single Ply Membrane Details
Mechanically Fixed System
Roof parapet with timber decking detail

MECHANICAL FIXINGS:-

Selection of fixings:-
 Deck - Metal/Timber/plywood
 FBS-5.8 fasteners
 Metal deck 15mm penetration to underside
 Timber deck 12mm penetration to underside

Deck - Concrete
 FHD-6.1 fasteners
 Concrete deck 25mm embedment

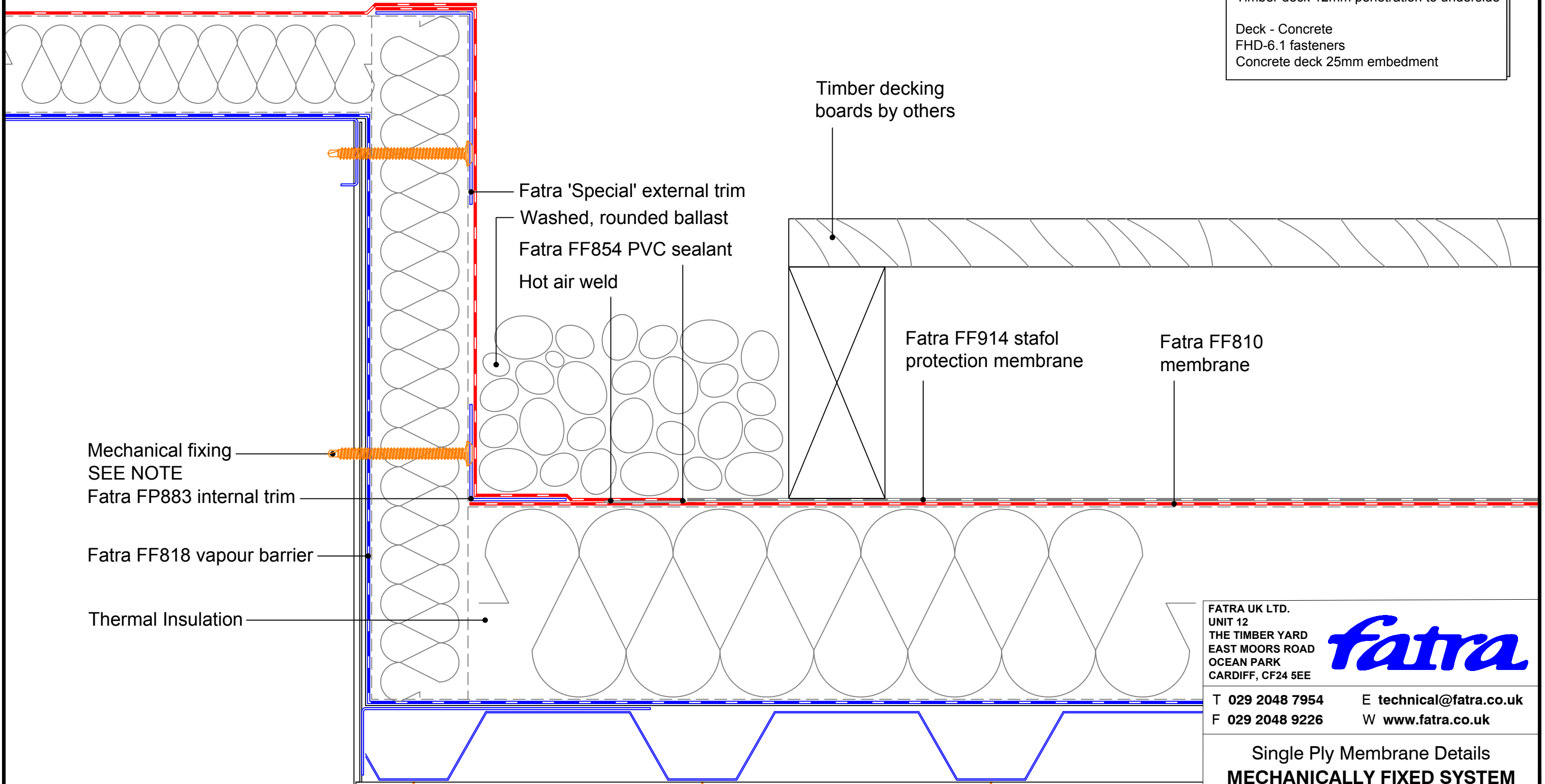

FATRA UK LTD.
 UNIT 12
 THE TIMBER YARD
 EAST MOORS ROAD
 OCEAN PARK
 CARDIFF, CF24 5EE



T 029 2048 7954 E technical@fatra.co.uk
 F 029 2048 9226 W www.fatra.co.uk

Single Ply Membrane Details
MECHANICALLY FIXED SYSTEM
ROOF PARAPET WITH TIMBER DECKING

DATE: JANUARY 2018	SCALE: 1:2 @ A3	DRAWN: LB
DRAWING NO: FATRA MF-43		REVISION: -

Single Ply Membrane Details
Mechanically Fixed System
Upstand to pitched tiles

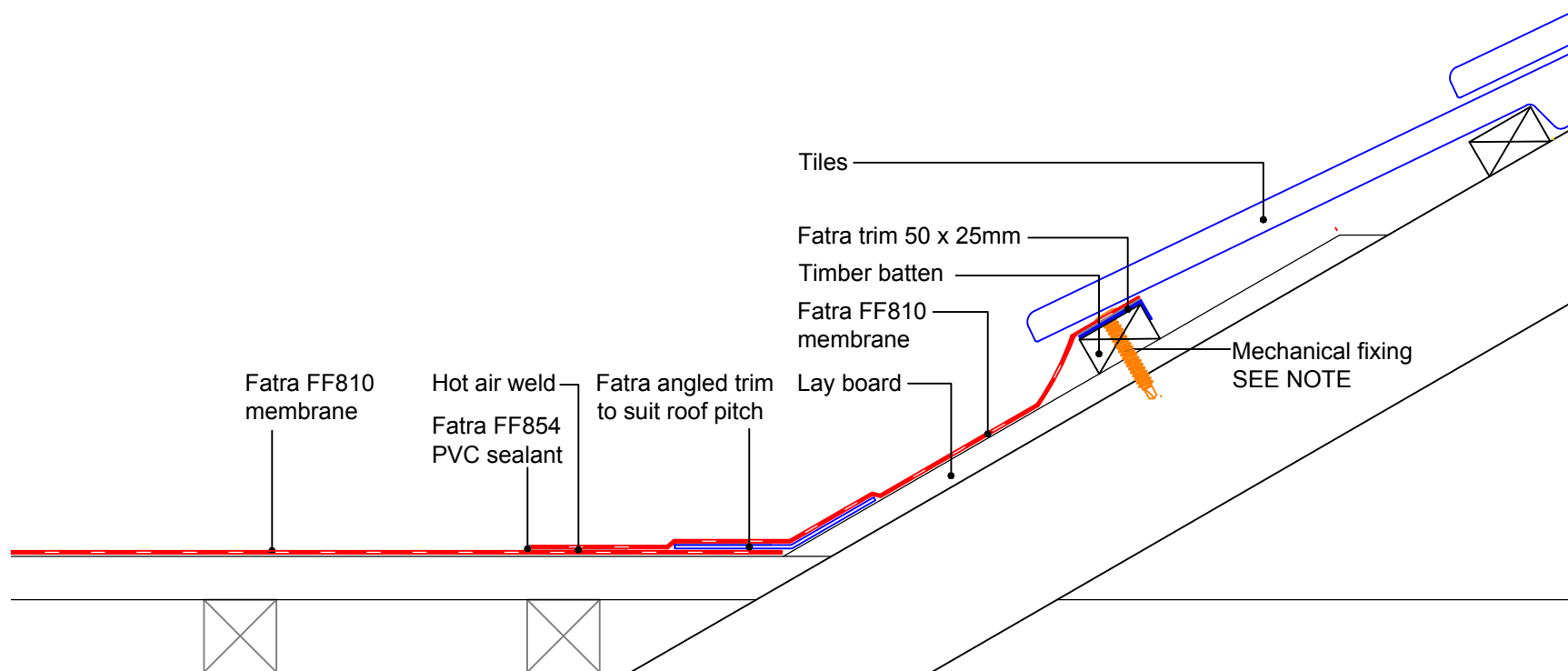

MECHANICAL FIXINGS:-

Selection of fixings:-
 Deck - Metal/Timber/plywood
 FBS-5.8 fasteners
 Metal deck 15mm penetration to underside
 Timber deck 12mm penetration to underside

Deck - Concrete
 FHD-6.1 fasteners
 Concrete deck 25mm embedment

FATRA UK LTD.
 UNIT 12
 THE TIMBER YARD
 EAST MOORS ROAD
 OCEAN PARK
 CARDIFF, CF24 5EE



T 029 2048 7954 E technical@fatra.co.uk
 F 029 2048 9226 W www.fatra.co.uk

Single Ply Membrane Details
MECHANICALLY FIXED SYSTEM
UPSTAND TO PITCHED TILES

DATE: JANUARY 2018	SCALE: 1:2 @ A3	DRAWN: LB
DRAWING NO: FATRA MF-46		REVISION: -

Single Ply Membrane Details
Mechanically Fixed System
Soil & vent pipe detail

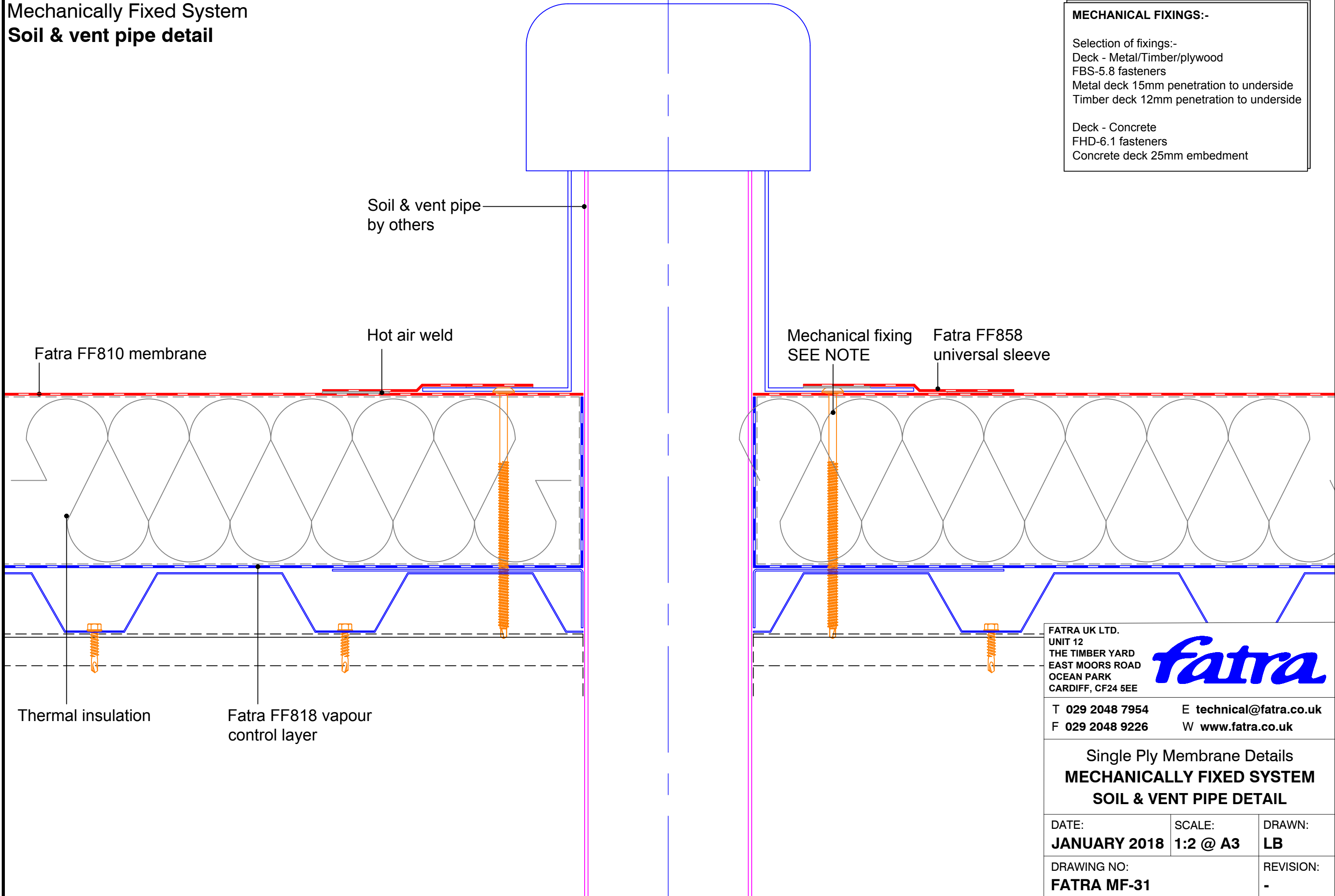

MECHANICAL FIXINGS:-

Selection of fixings:-
 Deck - Metal/Timber/plywood
 FBS-5.8 fasteners
 Metal deck 15mm penetration to underside
 Timber deck 12mm penetration to underside

Deck - Concrete
 FHD-6.1 fasteners
 Concrete deck 25mm embedment

Soil & vent pipe
by others

Fatra FF810 membrane

Hot air weld

Mechanical fixing
SEE NOTE

Fatra FF858
universal sleeve

Thermal insulation

Fatra FF818 vapour
control layer

FATRA UK LTD.
 UNIT 12
 THE TIMBER YARD
 EAST MOORS ROAD
 OCEAN PARK
 CARDIFF, CF24 5EE



T 029 2048 7954 E technical@fatratra.co.uk
 F 029 2048 9226 W www.fatratra.co.uk

Single Ply Membrane Details
MECHANICALLY FIXED SYSTEM
SOIL & VENT PIPE DETAIL

DATE: JANUARY 2018	SCALE: 1:2 @ A3	DRAWN: LB
DRAWING NO: FATRA MF-31		REVISION: -

Single Ply Membrane Details

Fully adhered system

Vertical outlet detail - Refurbishment

MECHANICAL FIXINGS:-

Selection of fixings:-
 Deck - Metal/Timber/plywood
 FBS-5.8 fasteners
 Metal deck 15mm penetration to underside
 Timber deck 12mm penetration to underside

Deck - Concrete
 FHD-6.1 fasteners
 Concrete deck 25mm embedment

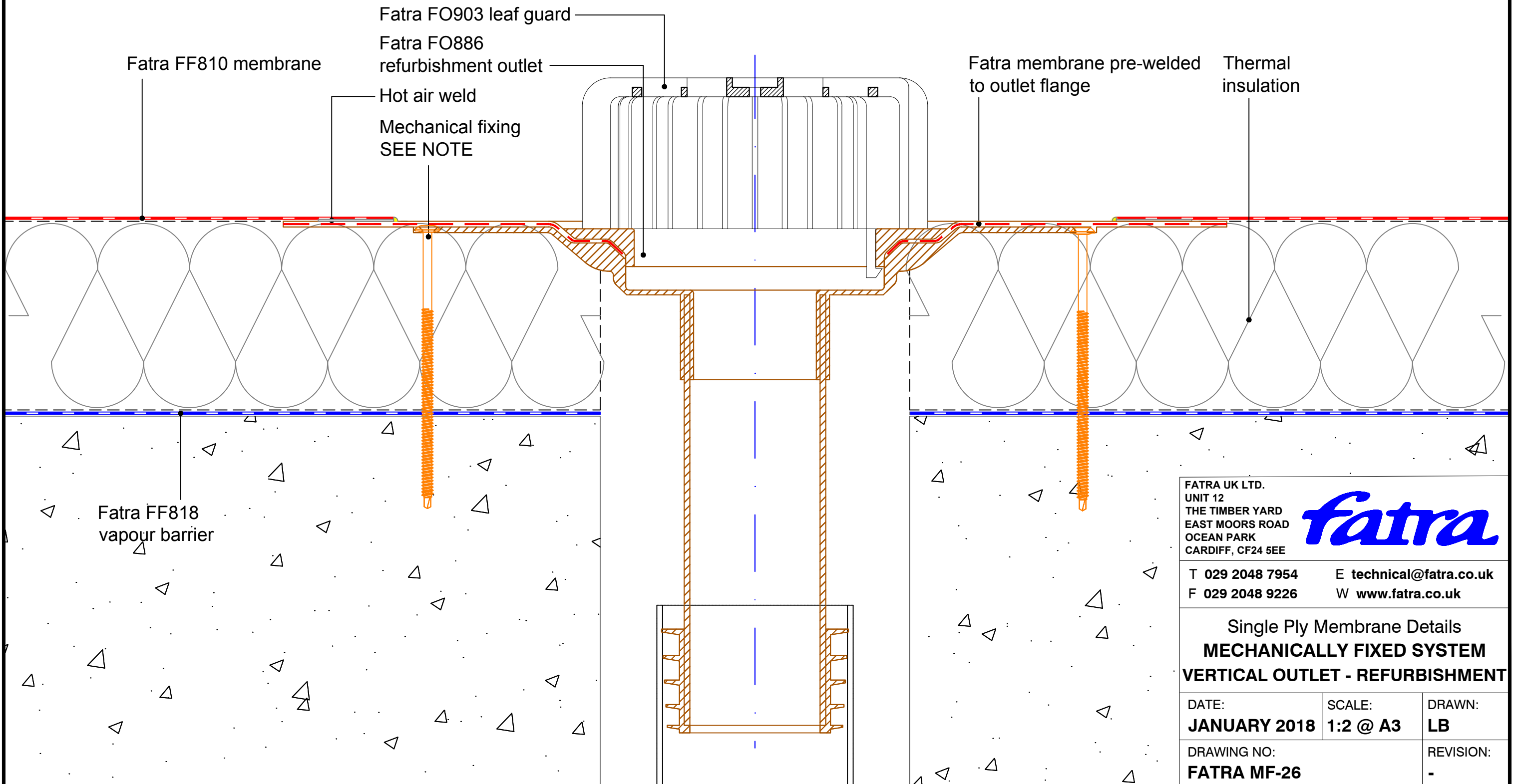

FATRA UK LTD.
 UNIT 12
 THE TIMBER YARD
 EAST MOORS ROAD
 OCEAN PARK
 CARDIFF, CF24 5EE



T 029 2048 7954 E technical@fatra.co.uk
 F 029 2048 9226 W www.fatra.co.uk

Single Ply Membrane Details
MECHANICALLY FIXED SYSTEM
VERTICAL OUTLET - REFURBISHMENT

DATE: JANUARY 2018	SCALE: 1:2 @ A3	DRAWN: LB
DRAWING NO: FATRA MF-26		REVISION: -

Single Ply Membrane Details
Mechanically Fixed System
Vertical outlet detail

MECHANICAL FIXINGS:-

Selection of fixings:-
 Deck - Metal/Timber/plywood
 FBS-5.8 fasteners
 Metal deck 15mm penetration to underside
 Timber deck 12mm penetration to underside

 Deck - Concrete
 FHD-6.1 fasteners
 Concrete deck 25mm embedment

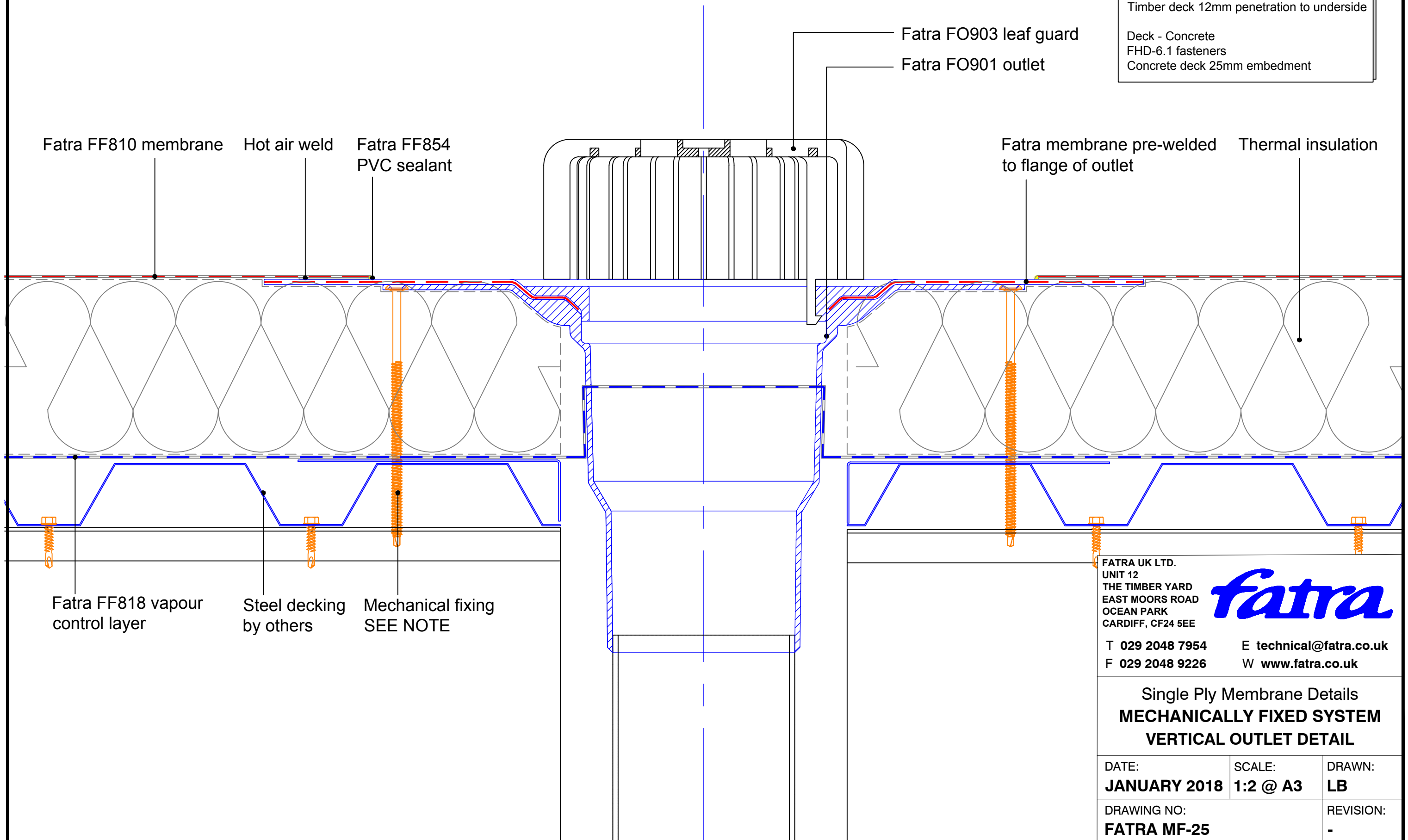

FATRA UK LTD.
 UNIT 12
 THE TIMBER YARD
 EAST MOORS ROAD
 OCEAN PARK
 CARDIFF, CF24 5EE



T 029 2048 7954 E technical@fatras.co.uk
 F 029 2048 9226 W www.fatras.co.uk

Single Ply Membrane Details
MECHANICALLY FIXED SYSTEM
VERTICAL OUTLET DETAIL

DATE: JANUARY 2018	SCALE: 1:2 @ A3	DRAWN: LB
DRAWING NO: FATRA MF-25		REVISION: -

Single Ply Membrane Details
 Mechanically Fixed System
Membrane walkway detail

Construction Note

Galvanised steel walkway plate is only required when using mineral fibre Thermal Insulation boards.
 PIR / dense foam boards do not require the extra protection unless specified.

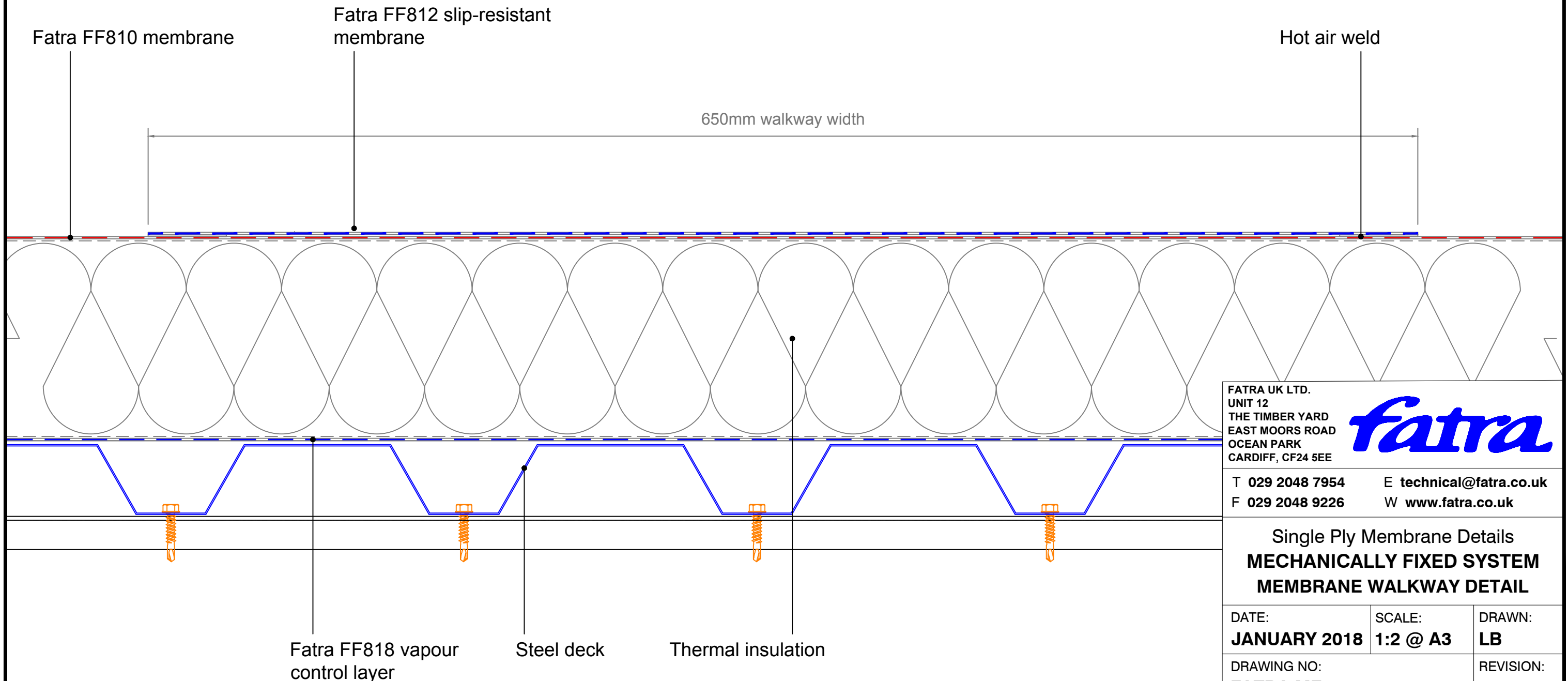

FATRA UK LTD.
 UNIT 12
 THE TIMBER YARD
 EAST MOORS ROAD
 OCEAN PARK
 CARDIFF, CF24 5EE



T 029 2048 7954 E technical@fatra.co.uk
 F 029 2048 9226 W www.fatra.co.uk

Single Ply Membrane Details
MECHANICALLY FIXED SYSTEM
MEMBRANE WALKWAY DETAIL

DATE: JANUARY 2018	SCALE: 1:2 @ A3	DRAWN: LB
DRAWING NO: FATRA MF-37		REVISION: -